



Guide for Electronically Filing Affordable Care Act (ACA) Information Returns for Software Developers and Transmitters

(Processing Year 2018)

Change/Document History

It will be assured that this document is current. Printed documents and locally copied files may become obsolete due to changes to the master document.

Version Number	Date	Summary of Changes	Changes Marked

Contents

1	Introduction	7
1.1	Purpose	8
1.2	Communications	8
1.2.1	AIR Web Site.....	8
2	Submitting the ACA Application for Transmitter Control Code (TCC).....	9
2.1	Transmitter and Issuer TCCs	12
2.2	Software Developer TCCs	13
3	Transmissions and Submissions	14
3.1	Transmission/Submission Definitions and Limitations	14
3.2	Uniquely Identifying the Transmission	15
4	Transmitting Information Returns	17
4.1	Transmitting via the User Interface (UI) Channel	17
4.2	Transmitting via the Application to Application (A2A) Channel.....	18
4.2.1	Transmission File and Soap Message via A2A	20
4.2.2	Strong Authentication	21
4.2.3	Certificate Management.....	22
4.2.4	Authorized Certificate Authorities.....	23
4.3	XML Overview for AIR	23
4.3.1	AIR XML Schema Package Structure	24
4.3.2	AIR XML Structure	25
4.3.3	Prohibited and Constrained Special Characters	25
4.3.4	Tag Names	26
4.3.5	Attributes	27
4.3.6	Repeating Group	27
4.3.7	AIR Schema and Business Rules.....	28
4.3.8	Validating Schema Versions.....	29
4.3.9	Example of Schema Versioning.....	31
4.4	Threat Mitigations in AIR Transmissions.....	32
4.4.1	Threat Mitigation through ISS-UI	39
4.4.2	Threat Mitigation through ISS-A2A.....	41
5	Validating the Transmission and Return Data.....	41

5.1 Transmission Validation	42
5.1.1 Missing or Multiple Attachments	43
5.1.2 Error Reading or Persisting the Form Data File	43
5.1.3 Manifest Verification Failure.....	43
5.1.4 Duplicate XML File Detected.....	44
5.1.5 XML File Schema Validation Failure.....	44
5.1.6 Business Rule Errors.....	45
6 Acknowledgement Files	46
6.1 Acknowledgement Schema.....	47
6.2 Retrieving Acknowledgements.....	48
6.2.2 Retrieving Acknowledgements via the UI Channel.....	51
6.2.3 Retrieving Acknowledgements via the A2A Channel.....	52
7 Corrections and Replacements.....	52
7.1 Corrections Process.....	52
7.1.1 Transmitting Corrections	54
7.2.2 Transmissions Rejected by AIR	56
7.2.3 Transmitting Replacements	56
7.2.3.1 Replacing an Original Transmission that Rejected.....	57
7.2.3.2 Replacing a ‘Replacement’ Transmission that Rejected.....	57
7.2.3.2.1 Replacing Submissions within a Partially Accepted Transmission	58
7.2.3.2.2 Replacing Submissions within a Partially Accepted ‘Replacement’ Transmission.....	59
7.2.3.2.3 Replacing Submissions from an Original Transmission that was Partially Accepted when the Replacement Submission(s) Transmission was Rejected.....	59
8 Extension of Time to File	60
9 Waiver from Filing Electronically	60
10 Appendix Additional Resources	61

Note: The Figures displayed throughout this publication are ‘examples’ only. The examples are visual snapshots of Schema data at the time of publication to be used as a reference.

Table of Tables

Table 2-1: TCC Roles	10
Table 2-2: Responsible Official Titles	11
Table 3-1: Transmissions Types	14
Table 4-1: List of Authorized Certificate Authorities	23
Table 4-2: Transmission Types	24
Table 4-3 Special Characters Not to Be Included in Any Data	25
Table 4-4: Allowable Characters	25
Table 4-5: List of Fault Codes (TPE Errors) for Tax Years 2015, 2016 and 2017	33
Table 5-1: AIR Error Categories	42
Table 5-2: Schema Validation Business Rules	45
Table 6-1: AIR Forms Acknowledgement Schema Elements	47

Table of Figures

Figure 2-1: Example of Transmitter TCC and Form Status	12
Figure 2-2: Software Package Identifiers and Status Indicators	13
Figure 2-3: Add Software Developer Package	14
Figure 3-1: Conceptual Structure of IRS AIR SOAP MTOM Attachments	15
Figure 3-2: Layout of Unique Transmission Identifier (UTID)	16
Figure 4-1: Sample of a Receipt ID via UI Channel	18
Figure 4-2: Sample XML of Receipt ID through A2A Channel	20
Figure 4-3: SOAP Message Structure	21
Figure 4-4: Form 1094/1095-B Schema Structure	27
Figure 4-5: Example of the Covered Individual Repeating Group	28
Figure 4-6: 1095-B Upstream Detail Type	29
Figure 4-7: Example of AIR Schema Information	30
Figure 4-8: Schema Samples for AIR Forms	32
Figure 4-9: Sample of an A2A Channel Fault Message	32
Figure 4-10: Sample of a UI Channel Fault Message	33
Figure 4-11: Example of UI Upload Page	40
Figure 4-12: UI Upload Page Showing the Search Error	41
Figure 6-1: Sample of an Error Data File	50
Figure 6-2: Sample of an Error Data File with TIN Validation (500)	51
Figure 7-1: Reference Records to be Corrected	53
Figure 7-2: Replacing a Rejected Transmission	58

1 Introduction

Publication 5165, *Guide for Electronically Filing Affordable Care Act (ACA) Information Returns (AIR) for Software Developers and Transmitters (Processing Year [PY] 2018)*, outlines the communication procedures, transmission formats, business rules and validation procedures for information returns transmitted electronically through the AIR System. To develop software for use with the AIR System, Software Developers, Transmitters, and Issuers should use the guidelines provided in this publication along with the Extensible Markup Language (XML) Schemas published on IRS.gov. The procedures in this publication should be used when the following information returns are transmitted electronically for TY2015, TY2016 and TY2017 in PY2018:

- **Form 1094-B**, *Transmittal of Health Coverage Information Returns*
- **Form 1095-B**, *Health Coverage*
- **Form 1094-C**, *Transmittal of Employer-Provided Health Insurance Offer and Coverage Information Returns*
- **Form 1095-C**, *Employer-Provided Health Insurance Offer and Coverage*

Note: This publication does not contain information or procedures for filing Form 1095-A.

The transmittal Forms 1094-B and 1094-C provide information about the Issuer of the ACA Information Returns and the Forms 1095-B and 1095-C provide information about the covered individuals. Generally, the Forms 1095-B and 1095-C will be submitted with their associated transmittals, Forms 1094-B and 1094-C; however, in certain circumstances, the Form 1094-C can be submitted alone. After these forms are processed by AIR, the status of each submission and a detailed acknowledgment is made available to each Transmitter.

Note: Please refer to Publication 1220, *Specifications for Electronic Filing of Form 1097, 1098, 1099, 3921, 3922, 5498 and W-2G*, for non-ACA Information Return instructions; Non-ACA Information Returns are electronically filed via the [Filing Information Returns Electronically \(FIRE\) system](#).

The procedures in this publication should also be used in conjunction with the most current version of the following publications:

- [Publication 4557](#)- *Safeguarding Taxpayer Data: A Guide for Your Business*: The purpose of this publication is to provide information on legal requirements to safeguard taxpayer data. The target audience is non-government businesses involved in the preparation and filing of income tax returns.
- [Publication 4600](#) – *Safeguarding Taxpayer Information Quick Reference Guide for Businesses*: The target audience is non-government businesses involved in the preparation and filing of tax returns. The purpose of this Publication is to provide information on requirements to safeguard taxpayer information, safeguarding techniques, and data security incidents.
- [Publication 5164](#)– *Test Package for Electronic Filers of Affordable Care Act (ACA) Information Returns (AIR)*: This publication contains general and program specific testing information for use in completing the ACA Assurance Testing System (AATS) process for business submissions. AATS is a process to test software and electronic transmissions prior to accepting Software Developers, Transmitters, and Issuers into the AIR program.

The following guides/documents provide additional guidance for filing electronically through AIR.

- [Publication 5258 - Affordable Care Act Information Returns \(AIR\) Submission Composition and Reference Guide](#): This guide provides:
 - Guidance to Internal Revenue Service (IRS) external partners (Software Developers, Transmitters, and Issuers) with composing submissions and transmission files that are sent to IRS for processing

- Description of the interaction between AIR and the Transmitter through the **Information Submission Services (ISS) User Interface (UI) and Application to Application (A2A) channels**
- **Automated Enrollment for ACA Providers, "The External Guide"** - IRS developed this guide for the AIR System authorized contacts who want to use **Automated Enrollment (AE) to enroll A2A Client Application Systems into the IRS Application to Application (A2A) channel**. The AE application provides authorized delegated users the ability to enroll and update the A2A Client Application System ID (ASID) using the Integrated Enterprise Portal (IEP).

AIR publications and guides are located on the [Affordable Care Act Information Returns \(AIR\) Program](#) page.

1.1 Purpose

The purpose of this publication is to provide the specifications to electronically file the ACA Information Returns (Forms 1094/1095-B and 1094/1095-C) with IRS.

Forms 1094/1095-B and 1094/1095-C are information returns under Section 6011(e)(2)(A) of the Internal Revenue Code which provides that any person, including a corporation, partnership, individual, estate, or trust, who is required to file 250 or more information returns, must file such returns electronically. The 250 or more information return requirement applies separately for each type of return and separately to each type of corrected return.

Note: All filers are encouraged to file the ACA Information Returns electronically even if they file less than 250 information returns.

All filing requirements apply individually to each reporting entity as defined by its separate Tax Identification Number (TIN). Issuers should retain a copy of information returns (or have the ability to reconstruct the data) for at least three years from the reporting due date.

1.2 Communications

IRS worked in partnership with many AIR stakeholders to develop the information contained within this publication. A Help Desk has been designated as the first point of contact for electronic filing issues. Software Developers and Transmitters/Issuers should contact the Help Desk; Toll free, at 1-866-937-4130 for assistance in the following areas:

- ACA Application for Transmitter Control Code (TCC)
- ACA Assurance Testing System (AATS) and Communication Testing
- Transmission Issues
- Rejected Transmissions/Submissions
- Business Rules and Error Code Resolution

Inquiries regarding issues with the AIR System and the new development of the forms related to the ACA Program may be sent to the airmailbox@irs.gov.

1.2.1 AIR Web Site

For information regarding the AIR System and electronic filing Affordable Care Act Information Returns go to [Affordable Care Act Information Returns \(AIR\) Program](#). The AIR program page provides:

- ACA Information Returns (AIR) System (Production and Testing) Status Page and Latest Updates
- ACA Information Returns (AIR) Program Overview
- What You Need To Know To Get Started

- Links to ACA Information Returns (AIR) Webinar Presentation Material
- Links to ACA Assurance Testing System (AATS) Information
- Links to E-Services Information
- Links to ACA Information Returns (AIR) Publications, Schemas, Business Rules and much more

If you encounter an issue or limitation that prevents an ACA Information Return from being submitted electronically through AIR, and the solution is not posted on the Affordable Care Act Information Return (AIR) Program webpage, please contact the Help Desk. The Service will then work on making the appropriate corrections or assisting with the issue or limitation. Until corrections can be implemented, AIR may develop “workarounds”, which are temporary changes to allow the return to be transmitted electronically. Workarounds will be posted by Tax Year (TY) and linked to the Schema and Business Rules page under the “Known Issues and Solutions” heading.

AIR uses QuickAlerts, an IRS e-mail service, to disseminate information quickly regarding AIR issues to subscribers. This service keeps tax professionals up to date on AIR issues throughout the year, with particular emphasis on issues during the filing season. After subscribing, customers will receive “round the clock” communications about issues such as electronic specifications and system information needed for Software Developers and Transmitters to transmit the Forms 1094/1095-B and 1094/1095-C to IRS. New subscribers may sign up through the "subscription page" link located on the [QuickAlerts "more" e-file Benefits for Tax Professionals](#) page.

2 Submitting the ACA Application for Transmitter Control Code (TCC)

If you are an employer or insurance issuer/carrier responsible for filing 250 or more ACA Information Returns, you are required to file them electronically. ACA Information Returns must be filed through AIR using an ACA Transmitter Control Code (TCC). ACA Information Returns may not be filed using any other Transmitter Control Code (FIRE TCC) or Electronic Identification Filing Number (EFIN), or Electronic Identification Transmission Number (ETIN).

Who should apply for an ACA Transmitter Control Code?

If you are transmitting information returns to IRS or if you are developing software to file information returns electronically, you must apply for one or more TCCs using the *ACA Application for Transmitter Control Code (TCC)* available online from e-Services on IRS.gov. A single application can be used to apply for multiple roles and the necessary TCCs.

The ACA Application for TCC contains three separate roles: Software Developer, Transmitter, and Issuer.

Complete the ACA Application for TCC if your firm or organization is performing one or more of the following roles:

- **Software Developer:** An organization writing either origination or transmission software according to IRS specifications.
- **Transmitter:** A third-party sending the electronic information returns data directly to IRS on behalf of any business. (**Note:** If you are transmitting returns for your own company, in addition to transmitting returns on behalf of another business, you do not need both the Transmitter and Issuer role. You can file all returns as a Transmitter.)

- **Issuer:** A business filing their own ACA Information Returns regardless of whether they are required to file electronically (transmit 250 or more of the same type of information return) or volunteer to file electronically. The term “Issuer” includes any person required to report coverage on Form 1095-B and any applicable large employer required to report offers of coverage on Form 1095-C and file the associated transmittal Form 1094-B or Form 1094-C.

Note: Issuers and Transmitters are collectively referred to as Transmitters throughout this document.

These roles are not mutually exclusive, for example, a firm or organization may be both a Transmitter and a Software Developer. In addition to the roles the firm or organization will perform, the application will require the transmission method for Transmitters and Issuers or the transmission method(s) the software packages will support. Each role will receive its own TCC to be used based on the activity being performed. For example, Software Developers performing Testing will use the Software Developer TCC. Do not use the Software Developer TCC to transmit Production files.

Note: If an organization requires more than one TCC for any given role, a responsible official listed on the application should contact the help desk to request an additional TCC.

If you are an Employer or Insurance Issuer/Carrier using a 3rd party to prepare and transmit your information returns to IRS, you do not need to obtain a TCC.

The table below provides examples of who should apply for a TCC.

Table 2-1: TCC Roles

What roles should I select on my ACA Application for Transmitter Control Code?			
Software Purchased or Developed?	If...	And	Then
Developed	I am a commercial Software Developer developing software and selling software packages to employers and insurance issuers/carriers,	I will transmit information for employers or insurance issuers/carriers.	Select both the Software Developer role and the Transmitter role on your application.
Developed	I am an employer or insurance issuer/carrier developing my own software package, or who has contracted with someone to develop a unique package for my sole use,	I will perform the software testing with IRS and transmit my own information returns.	Select the role of Software Developer and Issuer on your application.
Purchased	I am an employer or insurance issuer/carrier purchasing a software package,	I will transmit my own information returns.	Select the role of Issuer on your application. Note: You may not use an Issuer TCC to transmit information returns for other employers or insurance issuers/carriers.

Purchased	I am an employer or insurance issuer/carrier purchasing a software package,	I will transmit my own information returns and transmit for other employers or insurance issuers/carriers.	Select the role of Transmitter on your application. Note: The TCC for a Transmitter can be used to transmit your own returns and others. You may not use an Issuer TCC to transmit information returns for other employers or insurance issuers/carriers.
-----------	--	---	---

Submitting the ACA Application for TCC begins with the Responsible Official and Contacts registering for e-Services. For more information on the registration process, search for "e-Services" on www.irs.gov and follow the guidance on the e-Services page. Once the registration is complete, including the confirmation process, the Responsible Official can begin the application for TCC process.

Each Responsible Official will need to sign the Terms of Agreement using the PIN that was selected during the e-Services registration process. Below are the available titles for Responsible Officials:

Table 2-2: Responsible Official Titles

Business Type	Title
Partnership and Limited Liability Partnership	Partner, General Partner, Limited Partner, LLC Member, Manager, Member, Managing Member, President, Owner, Tax Matter Partner (TMP)
Corporations, Personal Service Corporation and Limited Liability Corporations	President, Vice President, Corporate Treasurer/Treasurer, Assistant Treasurer, Chief Accounting Officer (CAO), Chief Executive Officer (CEO), Chief Financial Officer (CFO), Tax Officer, Chief Operating Officer (COO), Corporate Secretary/Secretary, Secretary Treasurer, Member
Association, Credit Union, Volunteer Organization, State Government Agency	President, Vice President, Treasurer, Assistant Treasurer, Chief Accounting Officer (CAO), Tax Officer, Chief Operating Officer (COO), Chief Executive Officer (CEO), Chief Financial Officer (CFO), Executive Director/Director, Chairman, Executive Administrator/Administrator, Receiver, Pastor, Assistant to Religious Leader, Reverend, Priest, Minister, Rabbi, Chairman, Secretary, Director of Taxation, Director of Personnel, Tax Officer
Sole Proprietor	Owner, Sole Proprietor, Member, Sole Member, Tribes

After all listed Responsible Officials have entered their PIN on the Terms of Agreement page, submit the application for processing. **Note:** All Responsible Officials and Contacts on the application must be registered with e-Services before the application can be submitted.

Responsible Official - individuals with responsibility for or the authority over the electronic filing of ACA Information Returns operation at the firm or organization location. Responsible Official is also the first

point of contact with IRS who has authority to sign original/revise ACA Application for TCC, and is responsible for ensuring that all requirements are adhered to. At least two Responsible Officials will need to be listed on the application. All Responsible Officials will be required to sign the application. A Responsible Official can also be a Contact on the application.

Contact - individuals who may be responsible for transmitting and/or are available for inquiries from IRS on a daily basis. There is a minimum of 2 required Contacts and a maximum of 10 Contacts allowed per application. **Note:** The Contact provided here is not required to be the same Contact provided on the Form 1094-B or Form 1094-C.

The application does not have to be completed in a single session. A tracking number is provided when the application is submitted or when the application is in “Saved” status.

Note: In certain situations, the information submitted requires further review by IRS before a TCC can be issued. In these cases, IRS will contact the Responsible Official of record regarding any additional information that may be needed.

Once an ACA Application for TCC is processed and completed, TCCs and Software IDs, if applicable, are sent via United States Postal Service (USPS) and are also available to be viewed on the summary screen of the applicant’s online application. Applicants will receive a separate letter containing the TCC for each role selected on their application.

2.1 Transmitter and Issuer TCCs

Depending on the roles selected on the application, one or more TCCs will be assigned. Each TCC will have an indicator of Test "T" or Production "P" and status of Active, Inactive, or Dropped. Transmitters and Issuers are issued a TCC in Production status. The Form T/P Indicator (1094/1095-B or 1094/1095-C) is in Test status, until required Communication Testing is conducted and passed. Once Communication Testing is passed, the associated Form T/P Indicators are moved to Production. Transmitters must then wait 48 hours after the Form T/P Indicators are moved to Production and may only use the TCC to transmit live data to Production. Once a Form T/P Indicator is moved to Production, the TCC cannot be used to transmit to the test environment. See the example below:

[Application History](#) | [Update Current Status](#)

TCC Information:

Role	T/P Indicator	TCC	Status	Add a TCC
Transmitter	P ▼	AA000	Active ▼	ADD

Form T/P Indicators:

Role	Forms	T/P Indicator	Transmission Method
Transmitter	1094/1095B	T ▼	ISS-A2A - System Enroller, ISS-UI for ACA Internet Transmitter
	1094/1095C	T ▼	ISS-UI for ACA Internet Transmitter, ISS-A2A - System Enroller

Figure 2-1: Example of Transmitter TCC and Form Status

Transmitters and Issuers are issued a TCC in Production status. The Form T/P Indicator (1094/1095-B or 1094/1095-C) is in Test status, until required Communication Testing is conducted and passed. Once Communication Testing is passed, the associated Form T/P Indicators are moved to Production. Transmitters must then wait 48 hours after the Form T/P Indicators are moved to Production and may only use the TCC to transmit live data to Production. Once a Form T/P Indicator is moved to Production, the TCC cannot be used to transmit to the test environment.

2.2 Software Developer TCCs

After selecting the Software Developer role on the application, additional information about the transmission method and the software package (type, year and forms supported) being developed is required. The TCC is permanently assigned in “Test” status; a separate Software ID is also assigned for each package. The tax year(s) for the information returns supported, transmission method(s), form type, and software package type (Commercial off the Shelf (COTS), Online, In-house) are also required. Each Software Package and form type has a separate status; if your Software Package supports more than one form type (e.g. Forms 1094/1095-B and 1094/1095-C), both forms must be in Production before the Software Package is moved in Production status.

Software IDs:

Year	SW Package	Status	Software Product Name	Forms	Software ID	Status	Transmission Method
2013	In-house Package	Test	Product 2 methods for both forms	1094/1095B	13A0000394	Test	ISS-UI for ACA Internet Transmitter, ISS-A2A - System Enroller
				1094/1095C	13A0000396	Test	ISS-UI for ACA Internet Transmitter, ISS-A2A - System Enroller, ISS-UI for ACA Internet Transmitter
2016	Online Package	Test	Product3	1094/1095B	16A0000398	Test	ISS-UI for ACA Internet Transmitter
2016	COTS Package	Test	test	1094/1095B	14A0000397	Test	ISS-A2A - System Enroller, ISS-A2A - System Enroller

Figure 2-2: Software Package Identifiers and Status Indicators

Software Package information must be updated annually through the ACA Application for TCC located on e-Services at IRS.gov. New Software IDs will be assigned for each tax year. To update your application, the Responsible Official should go to the Application Details page and click the "Add" button under the Software Developer Package List.

Figure 2-3: Add Software Developer Package

3 Transmissions and Submissions

3.1 Transmission/Submission Definitions and Limitations

A **transmission** is defined as a separate package of electronic AIR documents which includes the Manifest and the Form Data File.

- The **Manifest** contains information about the Transmitter, transmission and the payload.
- The **Form Data File** contains one or more submissions in XML format.

Transmission requirements:

- Must consist of one or more submissions
- Must *not* contain submissions of different types (must not have both Forms 1094/1095-B and 1094/1095-C in the same transmission)
- Must *not* contain submissions for more than one tax year (must not have Tax Year 2015 and Tax Year 2016 in the same transmission)
- Must *not* contain multiple Transmission types (Original, Correction, and Replacement)
- The Form Data File (UI) or Message Transmission Optimization Mechanism (MTOM) (A2A) attachments may not exceed 100 MB of uncompressed native XML
- Must include the “*TransmissionTypeCd*” that identifies the type of transmission as follows:

Table 3-1: Transmissions Types

Allowed Data Value	Description
‘O’	A transmission containing original records
‘C’	A transmission containing correction records
‘R’	A transmission containing replacement records

Message Transmission Optimization Mechanism (MTOM) attachment is a World Wide Web Consortium (W3C) standard that provides a method of efficiently sending binary data to and from Web services.

For the purposes of this document, a **submission** is defined as the combination of a single transmittal form (Form 1094-B or Form 1094-C) and its associated information return (Form 1095-B or Form 1095-C). For example a submission is either:

- One Form 1094-B and one or more Form(s) 1095-B or
- One Form 1094-C and one or more Form(s) 1095-C or
- One Form 1094-C and zero Forms 1095-C, whenever the Form 1094-C is marked as a correction to an Authoritative Transmittal (for a previously accepted Form 1094-C)

Submission (Form Data File) requirements:

- The reported number of information returns on the transmittal form (Form 1094-B or 1094-C) must match the actual number of information returns (Form 1095-B or 1095-C) in the submission
- If a submission is larger than 100 MB, it must be split into two or more transmissions in the following way:
 - In one transmission, the first submission will consist of a single Form 1094 and as many associated Forms 1095 as will fit within the 100 MB limit
 - In the next transmission, the second or subsequent submission(s) will consist of a single Form 1094, and the remainder of as many associated Forms 1095 as can be contained without exceeding the 100 MB size limit
- Must *not* contain records of different form types (must not have both Forms 1095-B and Forms 1095-C in the same submission)
- Must *not* contain records for more than one tax year in the same submission

The conceptual structure of AIR **Simple Object Access Protocol (SOAP)** MTOM attachments (A2A channel) and the Form Data File attachment (UI channel) are depicted in Figure 3-1.

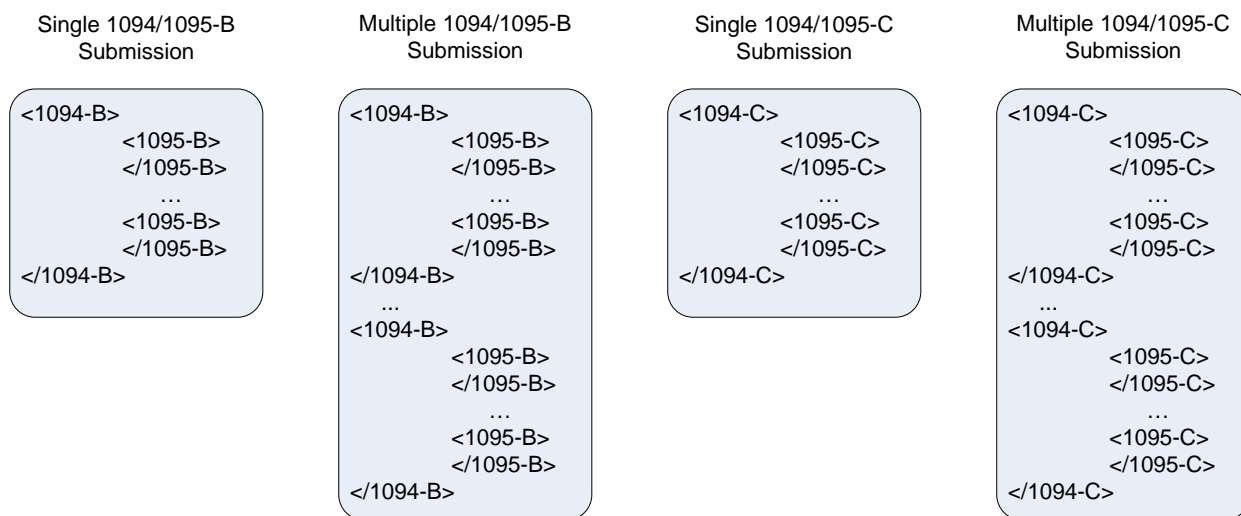

Figure 3-1: Conceptual Structure of IRS AIR SOAP MTOM Attachments

3.2 Uniquely Identifying the Transmission

The XML Schemas for Forms 1094/1095-B and 1094/1095-C include elements designed to uniquely identify ACA Information Returns transmissions, submissions within the transmission, and records within the submission. Transmitters must uniquely identify each transmission with a **Unique Transmission ID (UTID)**.

The format for the UTID includes various fields separated by colons (:) as follows:

- **UUID** – a **universally unique identifier** (UUID) is an identifier standard defined by the Internet Engineering Task Force (IETF) in Request For Comments (RFC) 4122. The UUID consists of a 16-octet (128-bit) number. This is a mandatory field; the UUID is represented by 32 hexadecimal digits, displayed in five groups separated by hyphens. For example:

550e8400-e29b-41d4-a716-446655440000

- **Application ID** – the Application ID will be SYS12 and is a mandatory field.
- **Transmitter Control Code** – is an uppercase alphanumeric field that will contain the Transmitter’s TCC and is mandatory.
- **Reserved** – is an empty field (no space between colons).
- **Request Type** – the Request Type defines the type of request which must be “T” (Transactional) and is mandatory.

The UTID for the transmission will be **550e8400-e29b-41d4-a716-446655440000:SYS12:BB002::T**

Unique Transmission Identifier (UTID)

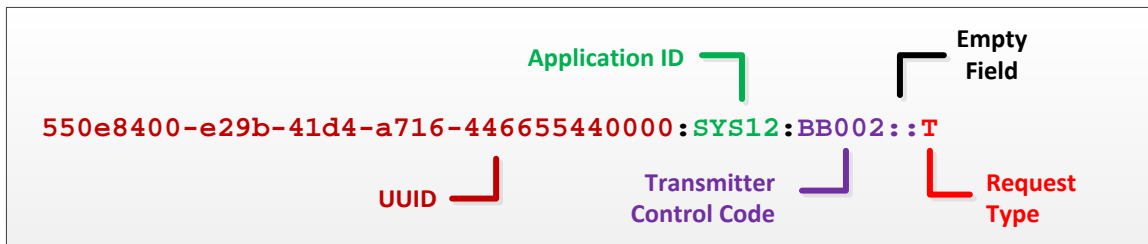

Figure 3-2: Layout of Unique Transmission Identifier (UTID)

Every transmission that AIR receives is validated to ensure that the UTID is unique (has not been previously submitted to the AIR System, including previously submitted rejected returns) and conforms to the pattern assigned in the XML Schema. If a UTID is missing, not sequential or not unique, the transmission is rejected and no further processing occurs. **Note: For TY2015, TY2016 and TY2017, the UTID can also be used to check the status of a transmission. The Schema allows either the Receipt ID or UTID to check status.**

Each transmittal (Form 1094) within a transmission will include a **Submission Identifier** (SID) that will start at one and increment by one for each subsequent transmittal. Do not include leading zeros. The SID is defined in the XML schema as a non-negative integer which is sufficiently large enough that the 100 MB Form Data File constraint dictates the number of submissions that can be included in a transmission.

Each record (Form 1095) within a submission will include a **Record Identifier** (RID) that will start at one and increment by one for each subsequent record.

When an error is identified, both Form 1094 and Form 1095 records are uniquely identified within a transmission by combining the Receipt ID, SID, and RID (as applicable), using the pipe symbol “|” as separator and returning them to the Transmitter as follows:

UniqueSubmissionId = RECEIPTID|SID
UniqueRecordId = RECEIPTID|SID|RID

Unique Submission Identifier (USID) and **Unique Record Identifier (URID)** enable:

- IRS to report errors to Transmitters that are clearly related to the specific record(s) within the submission and the transmission
- Transmitters to send corrected records to the IRS precisely identifying the record to be corrected
- Both IRS and Transmitters to track transmissions and submissions

4 Transmitting Information Returns

This section provides an overview of transmission methodology, transmission composition, as well as data structure needed to successfully transmit ACA Information Returns to IRS. The data exchanged between the Transmitters and the ACA Information Return (AIR) System via XML files or messages conforms to the **Simple Object Access Protocol (SOAP)**. There are two data communication channels between external clients and the AIR System: Both channels require the submissions to be self-contained in a single uncompressed XML formatted file. AIR will allow the Transmitter to transmit submissions to IRS and retrieve acknowledgements for those transmissions from IRS.

- **The ISS-User Interface (UI) Channel (Web Browser)** –The XML forms are created using the published XML schemas located on the [Affordable Care Act Information Returns \(AIR\) Program](#) page and then uploaded to the AIR System via the UI Channel. This data is exchanged using the HyperText Transfer Protocol (HTTPS) protocol over a Transport Layer Security (TLS) connection and then converted to SOAP.
- **The ISS-Application to Application (A2A) Channel** –The data is exchanged in SOAP messages using the Web Application request-response model transport mechanism over an HTTPS connection.

All information returns transmitted to IRS undergo a series of checks in the Portal. If any of these checks fail, the Transmitter will receive a fault response (an error prefixed with “TPE”), and a Receipt ID is not provided. The list of “TPE” errors is shown in Table 4-5. If every validation passes, the transmission continues to be processed in AIR, where additional validations are performed, (i.e., Schema and Manifest TCC) and a Receipt ID is generated.

Generally, the Receipt ID is returned to the Transmitter almost immediately after a successful transmission. For ISS-UI, the Receipt ID will be displayed via web browser upon successful transmission. For ISS-A2A, the Receipt ID will be part of the system-to-system response. The Receipt ID does not provide proof that the ACA Information Returns in the transmission were either accepted or rejected. The Receipt ID does provide proof that IRS received the file. The Transmitter must retrieve their Acknowledgement to obtain proof of acceptance or rejection. The Correction and Replacement process also utilize the Receipt ID in combination with the Submission and Record Identifiers as described later in Section 7.

For more information on how to compose submission and transmission files sent to IRS for processing using the AIR System, refer to Publication 5258, *AIR Submission Composition and Reference Guide*, located on the [Affordable Care Act Information Returns \(AIR\) Program](#) page.

4.1 Transmitting via the User Interface (UI) Channel

Transmitters must have completed the e-Services Registration, must have an ACA Transmitter Control Code (TCC), and must be using IRS approved Software to submit returns and retrieve acknowledgements. See Section 2 above for information on completing the e-Services Registration and applying for an ACA TCC. The Transmitter will be required to log in to the IEP using the links found on the Affordable Care Act Information Returns (AIR) Program page:

- AIR UI Channel Login AATS (Testing)

- AIR UI Channel Login Production

The Transmitter is required to upload two uncompressed native XML files to the AIR System: A **Manifest File**, which includes all of the Transmitter’s information and the **Form Data File**, which includes the Forms 1094/1095-B or Forms 1094/1095-C data.

IRS Portal will perform authentication and authorization, threat mitigation, and initial validation on the transmission. IRS Portal will return a fault response (an error prefixed with “TPE”), if a transmission contains a threat, or if a transmission fails initial validation. The list of “TPE” errors is shown in Table 4-5.

The AIR System validates the Manifest and Form Data File and performs additional security checks and XML Schema validation on the inbound transmission. If threats are detected or XML Schema validation fails, IRS will reject the transmission and inform the Transmitter of the rejection. If no security threats are detected, AIR returns a Receipt ID and a Timestamp to the Transmitter in the web browser as part of the synchronous session. The Receipt ID is the key information required for a Transmitter to retrieve the acknowledgement for the respective transmission.

Note: The Receipt ID returned to the Transmitter should be kept with the transmission and protected from loss or deletion.

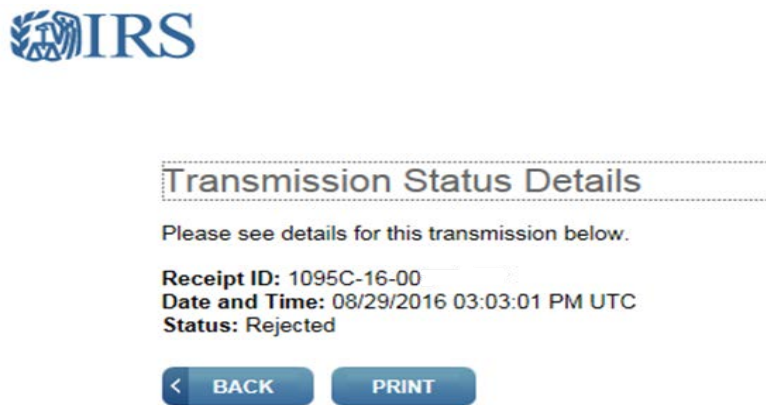

Figure 4-1: Sample of a Receipt ID via UI Channel

For more specific information on creating transmission files for the UI channel, refer to Publication 5258, *AIR Submission Composition and Reference Guide*, located on the [Affordable Care Act Information Returns \(AIR\) Program](#) page.

4.2 Transmitting via the Application to Application (A2A) Channel

To invoke the A2A channel, Transmitters must have an active IRS e-Services account and an ACA Transmitter Control Code (TCC). In addition they must have completed the Automated Enrollment application and be using IRS approved Software to submit returns and retrieve acknowledgements in Production. See Section 3 above for information about obtaining an account and applying for an ACA TCC.

IRS uses SOAP with **HyperText Transfer Protocol (HTTP)** binding for the transmission file, which are SOAP messages transported over a HTTPS connection (HTTP over TLS – Transport Layer Security) protocol. A comprehensive understanding of Web Service SOAP messaging and Web Services Standards is necessary in order to create software capable of transmitting data to IRS.

The Transmitter will be required to include their digital certificate and a digitally signed hash of certain message structures in the WS-Security Header of the SOAP Message and invoke the appropriate URL for the Web Service endpoint that exposes the IRS-ACASubmitService within the ACAGetTransmitterBulkRequestService.wsdl. The Transmitter is required to transmit a SOAP Message in a SOAP Envelope that consists of the SOAP Header, and the SOAP Body. The SOAP Header includes the Transmitter information. The SOAP Body consists of Forms 1094/1095-B or Forms 1094/1095-C data in an uncompressed native XML file that is attached to the SOAP Message as an MTOM encoded attachment.

SOAP messages are exchanged with IRS using the Web Services request-response model transport mechanism using the HTTPS protocol. For specific information on creating A2A Messages, please refer to Publication 5258, *AIR Submission Composition and Reference Guide*, located on the [Affordable Care Act Information Returns \(AIR\) Program](#) page.

IRS Portal will perform authentication and authorization, threat mitigation, and initial validation on the transmission. IRS Portal will return a fault response (an error prefixed with “TPE”), if a transmission contains a threat, if a transmission fails initial validation, or if a connection with the endpoint cannot be established. The list of “TPE” errors is shown in Table 4-5.

The AIR System validates the SOAP message and performs additional security checks and XML Schema validation on the inbound transmission. If threats are detected or XML Schema validation fails, IRS will reject the transmission and inform the Transmitter of the rejection. If no security threats are detected, AIR returns a Receipt ID, the UTID, and a Timestamp to the Transmitter in the SOAP Response message as part of the synchronous session. The Receipt ID or the UTID is the key information required for a Transmitter to retrieve the acknowledgement for the respective transmission. **Note:** The Receipt ID returned to the Transmitter should be kept with the transmission and protected from loss or deletion.

If the Transmitter does not receive the Receipt ID for some reason (e.g., the session times out or is terminated) or it is accidentally lost or deleted, call the Help Desk, toll-free, at 1-866-937-4130 and request the Receipt ID for the transmission. The Help Desk assistor will require the user to identify themselves and the UTID for the transmission in question in order to provide the respective Receipt ID.

```

xmlns:ns3="http://docs.oasis-open.org/wss/2004/01/oasis-200401-wss-wssecurity-utility-1.0.xsd"
xmlns:ns4="http://www.w3.org/2000/09/xmldsig#"
xmlns:acaBusHeader="urn:us:gov:treasury:irs:msg:acabusinessheader"
xmlns:ns6="urn:us:gov:treasury:irs:msg:irsacabulkrequesttransmitter"
xmlns:ns7="http://docs.oasis-open.org/wss/2004/01/oasis-200401-wss-wssecurity-secext-1.0.xsd"
xmlns:ns8="urn:us:gov:treasury:irs:msg:acasecurityheader">
<UniqueTransmissionId>Ae2320b33-f329-31d4-a716-394655440000:SYS12:XXXXXX::T
  </UniqueTransmissionId>
<irs:Timestamp>2016-11-16T21:18:58Z</irs:Timestamp>
</acaBusHeader:ACABusinessHeader>
</soap:Header>
<soap:Body>
<acaBodyReq:ACABulkRequestTransmitterResponse
xmlns:irs="urn:us:gov:treasury:irs:common" xmlns="urn:us:gov:treasury:irs:ext:aca:air:7.0"
xmlns:ns3="http://docs.oasis-open.org/wss/2004/01/oasis-200401-wss-wssecurity-utility-1.0.xsd"
xmlns:ns4="http://www.w3.org/2000/09/xmldsig#"
xmlns:ns5="urn:us:gov:treasury:irs:msg:acabusinessheader"
xmlns:acaBodyReq="urn:us:gov:treasury:irs:msg:irsacabulkrequesttransmitter"
xmlns:ns7="http://docs.oasis-open.org/wss/2004/01/oasis-200401-wss-wssecurity-secext-1.0.xsd"
xmlns:ns8="urn:us:gov:treasury:irs:msg:acasecurityheader">
  <TransmissionStatusCd>Processing</TransmissionStatusCd>
  <irs:ReceiptId>1095B-15-00000485</irs:ReceiptId>
</acaBodyReq:ACABulkRequestTransmitterResponse>
</soap:Body>

```

Figure 4-2: Sample XML of Receipt ID through A2A Channel

For more specific information on creating transmission files for the A2A channel, refer to Publication 5258, *AIR Submission Composition and Reference Guide*, located on the [Affordable Care Act Information Returns \(AIR\) Program](#) page.

4.2.1 Transmission File and Soap Message via A2A

The AIR transmission file is a MIME (Multipurpose Internet Mail Extensions) multipart document that contains two parts that conforms to “SOAP message with attachments” standard as given below:

- The first part of the multi-part document is the **SOAP envelope** (as described below) maintains transmission level information
- The second part of the document is a **SOAP attachment** that contains the ACA Information Return Submissions

SOAP is an XML based protocol used to encode the information in Web Service request and response messages before transmitting them over a network. A SOAP message is a simple XML document that consists of a SOAP Envelope with the following elements:

- A SOAP Header element that contains header information (ACA Header, WS-Addressing and Manifest)
- A SOAP Body element that contains request and response information and the reference to the MTOM (Message Transmission Optimization Mechanism) attachment
- A SOAP Fault element containing errors and status information

The second part of the message, MIME (Multipurpose Internet Mail Extension) is the SOAP attachment which contains the ACA Information Return Submission(s) as an MTOM encoded attachment. See example below.

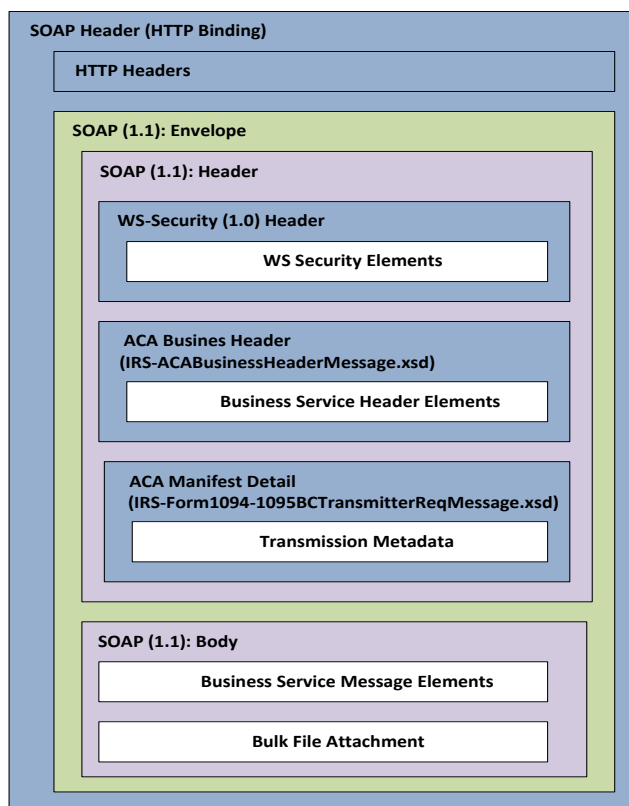

Figure 4-3: SOAP Message Structure

4.2.2 Strong Authentication

All external partner communication will need to support encryption using TLS 1.1 and TLS 1.2 Federal Information Processing Standards (FIPS) Publication 140-2. Compliant cryptography will be used for strong and secure communication between Transmitters and IRS.

The A2A registration and enrollment process for Transmitters and their application system is an automated process. The user can log into the Information Submission Service (ISS) and access the Automated Enrollment (AE) application to enroll and maintain their application identifications. The authorized user can perform the following functions relative to their A2A Client System ID (ASID) for their organization:

- Enroll, Update, and Un-enroll ASID
- View a deleted ASID
- Inactivate, Activate ASID
- Replace the certificate for ASID

The Automated Enrollment for ACA Providers External Guide describes the automated enrollment process and can be found on the [Affordable Care Act Information Returns \(AIR\) Program](#) page.

IRS requires strong authentication when transmitting via the A2A channel, which will affect authentication techniques for all A2A Web services. The strong authentication certificate/credential will replace the password and the ACA Information Returns Web Service Endpoint, Web Services Description Language (WSDL) will accommodate this credential. Each Transmitter will be required to register their certificate with AIR through the AE application. Software Developers must use the set of WSDL files provided by IRS to build their application so that

they can use strong authentication. The WSDL files are not automatically sent upon download of the certificate/credential.

Note: To request the WSDLs, the Responsible Official, or an official identified as a Contact on the AIR TCC Application, must send an email to the AIR Mailbox (airmailbox@irs.gov) with “WSDLs” in the subject line. The email request must include your company name and AIR TCC. The WSDLs will be forwarded upon confirmation of the TCC application and contact information.

Publication 5258, *AIR Submission Composition and Reference Guide*, explains the integration and uses of this IRS-provided client code sample to support certificate-based authentication for AIR A2A Web services. In addition to the code itself, this guide provides necessary information for developers to use when integrating the new feature into client software that communicates with A2A Web services.

4.2.3 Certificate Management

IRS requires the use of client digital (X.509) certificates issued by IRS-designated certificate authorities (see listing of approved Certificate Authorities in Section 4.2.4) to provide enhanced authentication of external partner application systems for A2A Web service processing. This capability is intended to mitigate threats defined in Treasury Department Publication 85-01, Department of the Treasury Information Technology (IT) Security Program, Vol. II, Handbook, Part 1, Section 5.4.4 Sensitive Systems.

To meet the requirements stated in the Treasury directive, the system will:

1. Provide verification of a digital signature of appropriate message parts produced using the private key for the X.509 certificate submitted with the authentication request, and shall prevent (fail) authentication if this verification fails.
2. Verify that a submitted X.509 certificate is properly formatted and is verified by appropriate CA signature, and shall prevent (fail) authentication if this verification fails.
3. Provide checks to ascertain that a submitted X.509 certificate has not been revoked, using most current Certificate Revocation List (CRL) resources from IRS-designated CAs, and shall prevent (fail) authentication if the certificate has been revoked. CRLs will be retrieved from each IRS-designated CA based on the schedule of available updates for that CA, so that the most up-to-date CRL will be made available for A2A authentication.
4. KeyInfo should use the KeyIdentifier tag which has the Base64 encoded certificate as its value. The Base64 encoded certificate should include the entire certificate chain including the root certificate and all the authorized CA certificates in order to pass the authentication process.
5. Transmitter/issuer should have one certificate per TCC/Role and it cannot be used for any other service, such as Modernized e-File (MeF).
6. Provide checks to ensure that a submitted X.509 certificate has not expired, and shall prevent (fail) authentication if the certificate has expired.
7. Ensure that a submitted X.509 certificate matches a certificate previously registered for the application system using data stored in IRS directory by an enrollment process, and shall prevent (fail) authentication if the match cannot be made.
8. Mitigate replay attacks for authentication.
9. Provide error handling by which any external failing strong authentication for any reason will receive a SOAP fault response message stating that “Authentication Failed.”
10. Provide adequate capacity for A2A certificate-based authentication.

11. Ensure that authentication attempts and results are audited and incorporated into log files for audit and forensic purposes.
12. Accommodate external users that have one or more sites (and client certificates) associated with a single Public Key Infrastructure (PKI) sponsor.
13. Register valid certificates for each enrolled external application system using an automated enrollment process. The authentication credentials structure shall be changed for all A2A Web service requests to accommodate session-less requests.

A2A Transmitters must use digital certificates (X.509) versus passwords upon proper enrollment and registration of the certificate. Encryption of the signing key is important on your system. Do not store an unencrypted copy of the signing key on your system. The signing key should be stored in a standard encrypted key store.

4.2.4 Authorized Certificate Authorities

Digital certificates bind digital information to physical identities and provide non-repudiation and data integrity. Before you begin the Automated Enrollment (AE) process, each entity should obtain one valid digital certificate issued by an approved Certificate Authority (CA). AE only recognizes and accepts digital certificates issued by IRS approved certificate authorities, listed below.

Table 4-1: List of Authorized Certificate Authorities

Certificate Authority	Type of Certificate
Identrust ACES SSL, naming a server	Go to Identrust and choose the Certificates menu and the type of ACES (currently ACES SSL). The type to choose is "ACES SSL Server".
Identrust ACES Business Representative, naming an individual	Go to Identrust and choose the Certificates menu and the type of ACES (currently ACES Business Representative). The type to choose is "ACES Business Representative".
ORC ACES Business Representative, naming an individual	Go to ACES ORC and follow the "Get Certificate" button. When you reach the "Select a Certificate" screen, choose "Business Representative". Please note that we have not tested with the Government Representative types and do not know if they will work with our system. We don't expect state and local governments to use ORC Government Representative certificates.
ORC ECA , naming a server	Go to ORC ECA and select "Order Component/Server Certificates". On the screen for order , please choose "Server Certificates".

4.3 XML Overview for AIR

IRS uses XML, a language that specifies the structure and content of electronic documents and files to define the electronic format of ACA Information Returns. This section explains some of the elements of an XML document. For detailed information regarding the IRS Submission File structure, including the XML Schema containing the required Tag Names/Element Names and Namespaces, refer to Publication 5258, *AIR Submission Composition and Reference Guide*, located on the [Affordable Care Act Information Returns \(AIR\) Program](#) page.

4.3.1 AIR XML Schema Package Structure

This section describes the AIR XML Schema file structure and how the schemas will be packaged as of the date this publication was issued.

Schemas for a given ACA Information Return are developed by the respective projects and submitted to the IRS Unstructured Data Practice (UDP) Group. The UDP Group integrates the project XML Schemas into a standard ACA XML Common Library. The ACA XML Common Library consists of several common XML Schema building blocks as follows:

- IRS-CAC.xsd – contains common aggregate components
- IRS-CBC.xsd – contains common basic components
- IRS-SDT.xsd – contains specialized data types

The ACA XML Common Library is built following IRS Enterprise Standards, Naming, and Design Rules.

The common XML Schema building blocks are packaged into a COMMON folder within the XML Library structure as follows:

XML Library *n.n*
COMMON

The ACA XML Library for AIR includes the following folders:

EXT

IRS-EXT-ACA-AIR-1094BC.xsd

MSG

Various .xsd and .xml – contains the Message, Form Data File, Manifest File, and Error Data File

SRV

ACAGetTransmitterBulkRequestService – the WSDL for the transmission endpoint

ACAGetTransmitterBulkRequestStatus – the WSDL for the retrieve acknowledgements endpoint

In addition to the schema files, there are six business rule files, one for each Form 1094-B, Form 1095-B, Form 1094-C, Form 1095-C, one for the Shared rules, and one for the Manifest/Header. The Manifest XML Schema includes an eFile type “*TransmissionTypeCd*” that identifies the type of transmissions as follows:

Table 4-2: Transmission Types

Allowed Data Value	Description
‘O’	A transmission containing original records
‘C’	A transmission containing correction records
‘R’	A transmission containing replacement records

The schema and business rule files can be found on the [Affordable Care Act Information Returns \(AIR\) Program](#) page.

4.3.2 AIR XML Structure

When entering character data into an XML document, it is important to ensure that the specified encoding supports the characters provided. By design, AIR uses Unicode Transformation Format-8 (UTF-8), without Byte Order Mark (BOM). AIR does not support any other encoding scheme (for example, UTF-16 and UTF-32).

4.3.3 Prohibited and Constrained Special Characters

Software Developers and Transmitters must not include certain special characters in any character data included in the XML of the SOAP message or the XML file attached to the SOAP message. The following special characters must not be included in any of the data fields for either Forms 1094/1095-B or Forms 1094/1095-C transmissions:

Table 4-3 Special Characters Not to Be Included in Any Data

Character	Character Description
--	<i>Double Dash</i>
#	<i>Hash Key</i>

IRS will reject a transmission that contains any of the special characters identified in Table 4-3, either in the SOAP Message or in the XML file, upon receipt.

- Example 1:* If a record has a last name data field containing **MyCorp #10**, then the transmission must not include the hash key/pound sign so that the data field instead contains **MyCorp 10**.

Example 1: If a record has an address data field containing **NoPlaceWay--Suite 4**, then the transmission must not include the double dash so that the data field instead contains **NoPlaceWay-Suite 4**.

The following special characters must be escaped before they are included in the data fields that allow escaped characters of either Forms 1094/1095-B or Forms 1094/1095-C transmissions:

Table 4-4: Allowable Characters

Character	Character Description	Character Allowed?	Escape Characters	Escape Character Allowed
&	<i>Ampersand</i>	Rejected	&	Allowed
'	<i>Apostrophe</i>	Rejected	'	Allowed
<	<i>Less Than</i>	Rejected	<	Allowed
“	<i>Quotation Mark</i>	Rejected	"	Allowed
>	<i>Greater Than</i>	Allowed	>	Allowed

***Caution:** “*PersonFirstNm*”, “*PersonMiddleNm*”, and “*PersonLastNm*” cannot contain any special characters. For example, if a record has a last name data field containing an apostrophe, such as “**O’Malley**”, the transmission cannot include the apostrophe or the escaped apostrophe characters. The apostrophe must be stripped and the last name data must be entered as “**OMALLEY**”. The transmission will be rejected if the apostrophe is used. As a rule the schema definitions must be followed.

However, the escaped apostrophe will be allowed in the “*BusinessNameLine1Txt*” and “*BusinessNameLine2Txt*” schema elements. Any special characters that are not listed in the Table 4-3 or Table 4-4 will be allowed as-is. For example, a hyphen is allowed in the “*PersonFirstNm*”, “*PersonMiddleNm*”, “*PersonLastNm*”, “*BusinessNameLine1Txt*” and “*BusinessNameLine2Txt*”.

Additional elements may also be restricted by XML schema data element definitions. For example, the schema does not allow the use of escaped Less Than or escaped Quotation within “*BusinessNameLine1Txt*” and “*BusinessNameLine2Txt*”.

4.3.4 Tag Names

Each field on the AIR Forms 1094/1095-B or Forms 1094/1095-C is identified using an XML tag name within the XML schema.

Tag names were created using the following conventions:

- A meaningful phrase with the first letter of each word capitalized and using no spaces (upper Camel case)
- A length of not more than 30 characters
- Standard abbreviations to meet the tag name 30 character limit

The Tag Names, also known as Element Names, were standardized by IRS for all ACA Information Return forms. A notional example of a simple XML element that identifies the record number in a submission would be:

```
<xsd:element ref="UniqueRecordId" minOccurs="1" maxOccurs="unbounded"/>
```

A notional example of a complex XML element that identifies all of the data elements required for Form 1094-B would be:

```

<xsd:complexType name="Form1094BUpstreamDetailType">
  <xsd:annotation>
    <xsd:documentation>
      <Component>
        <DictionaryEntryNm>Form 1094-B Upstream Detail Type</DictionaryEntryNm>
        <MajorVersionNum>3</MajorVersionNum>
        <MinorVersionNum>0</MinorVersionNum>
        <VersionEffectiveBeginDt>2016-07-05</VersionEffectiveBeginDt>
        <VersionDescriptionTxt>Initial version</VersionDescriptionTxt>
        <DescriptionTxt>Form 1094-B - Transmittal of Health Coverage Information Returns</DescriptionTxt>
      </Component>
    </xsd:documentation>
  </xsd:annotation>
  <xsd:sequence>
    <xsd:element ref="SubmissionId"/>
    <xsd:element ref="OriginalUniqueSubmissionId" minOccurs="0"/>
    <xsd:element ref="TestScenarioId" minOccurs="0"/>
    <xsd:element ref="irs:TaxYr"/>
    <xsd:element ref="BusinessName" minOccurs="1" maxOccurs="1"/>
    <xsd:element ref="BusinessNameControlTxt" minOccurs="0"/>
    <xsd:element ref="irs:TINRequestTypeCd" minOccurs="0"/>
    <xsd:element ref="irs:EmployerEIN"/>
    <xsd:element ref="ContactNameGrp" minOccurs="0"/>
    <xsd:element ref="ContactPhoneNum" minOccurs="0"/>
    <xsd:element ref="MailingAddressGrp" minOccurs="0"/>
    <xsd:element ref="Form1095BAttachedCnt" minOccurs="0"/>
    <xsd:element ref="Form1095BUpstreamDetail" maxOccurs="unbounded"/>
    <xsd:element ref="JuratSignaturePIN" minOccurs="0"/>
    <xsd:element ref="PersonTitleTxt" minOccurs="0"/>
    <xsd:element ref="irs:SignatureDt" minOccurs="0"/>
  </xsd:sequence>
  <xsd:attribute name="recordType" type="xsd:string" use="required"/>
  <xsd:attribute name="LineNum" type="xsd:integer" use="required"/>
</xsd:complexType>

```

Figure 4-4: Form 1094/1095-B Schema Structure

4.3.5 Attributes

Attributes provide additional information or describe a constraint of a data element.

- The first letter of the first word of an attribute name is lower case; the first letter of each subsequent word is capitalized (lower camel case).

For instance, in the example of the simple XML element *Form1095BUpstreamDetail* above, the attribute `maxOccurs="unbounded"` identifies that there is no limit to the number of Forms 1095-B that can be included in the XML. (However, the number of Forms 1095-B included in a submission is constrained by the 100 MB file size limit.)

4.3.6 Repeating Group

Repeating groups are specified in XML schema definitions using the `minOccurs` and `maxOccurs` facets on sequence or choice definitions. An example of a repeating group is as follows:

```
<xsd:element ref="EmployerCoveredIndividual" maxOccurs="unbounded"/>
```

The element ‘CoveredIndividualGrp’ allows a maximum of 99 groups within each 1095 record that is submitted. Beginning and ending tags are necessary for each group submitted. The reference element resolves to the eFile Type *EmployerCoveredIndividualType*:

```
<xsd:element name="CoveredIndividualGrp" type="EmployerCoveredIndividualType">
```

EmployerCoveredIndividualType is a complex data element that includes the nodes Covered Individual Name, Social Security Number or Date of Birth, and several other indicators required for the repeating group. All of the elements of the *EmployerCoveredIndividualType* repeat as each *CoveredIndividualGrp* are reported.

```
<xsd:sequence>
  <xsd:element ref="CoveredIndividualName" minOccurs="1" maxOccurs="1"/>
  <xsd:element ref="PersonNameControlTxt" minOccurs="0"/>
  <xsd:element ref="irs:TINRequestTypeCd" minOccurs="0"/>
  <xsd:element ref="irs:SSN" minOccurs="0"/>
  <xsd:element ref="BirthDt" minOccurs="0"/>
  <xsd:choice minOccurs="0">
    <xsd:element ref="CoveredIndividualAnnualInd" minOccurs="1"/>
    <xsd:element ref="CoveredIndividualMonthlyIndGrp" minOccurs="1"/>
  </xsd:choice>
</xsd:sequence>
```

Figure 4-5: Example of the Covered Individual Repeating Group

The ability to repeat information within the XML Schema is the electronic equivalent of attaching additional forms when there is insufficient space on the form to include all of the information that must be filed (e.g., If there are more than six covered individuals, complete one or more additional Forms 1095-B, Part IV).

4.3.7 AIR Schema and Business Rules

A schema is an XML document that specifies the data elements, structure and rules for the transmission Manifest and each form or document. In addition to formats defined by schemas, information returns must also adhere to business rules, which provide a second level of validation for information returns processed by the AIR System.

IRS created an XML schema for each of the different types of ACA Information Returns (Form 1094-B, Form 1094-C, Form 1095-B, and Form 1095-C), Transmission File, and Acknowledgement File. Each schema also has a respective set of business rules that are used during AIR validation.

Within the XML schema, data elements are the basic building blocks of an XML document. Schemas recognize two categories of element types: simple and complex. A simple type element contains only one data type and may only have documentation attributes, such as description or line number. A complex type element is an element that has one or more attributes or is the parent to one or more child elements.

The Transmitter and Issuer have the responsibility to provide information as specified by IRS forms, instructions and regulations. **Note:** The software used to transmit AIR documents to IRS must be capable of putting the information in the specified schema while also abiding by all applicable business rules.

The AIR schemas will no longer allow empty or null values within schema tags. All data elements present by virtue of an opening and a closing tag must contain a value. Empty or null tags (even for optional data elements) will result in a transmission rejection. **Do not include tags for optional data elements that are empty.**

Each year, new legislation and/or improvements to IRS programs impact IRS forms and processing procedures. IRS evaluates these changes to determine if updates to the XML schemas and business rules are necessary.

When the AIR schemas are posted on the [Affordable Care Act Information Returns \(AIR\) Program page](#), IRS will identify when the schemas are available in the AATS and Production environments. Software Developers are not required to retest when new schemas (minor or major) are posted. However, IRS strongly recommends the use of AATS to retest when Software Developers update their software in response to schema changes. Links to the

AIR XML Schemas and Business Rules are located on the [Affordable Care Act Information Returns \(AIR\) Program](#) page.

Note: If there are critical changes required due to late legislation changes, national disasters, or errors identified during testing or production, IRS may issue updated XML schemas and business rules after December and during the processing year.

General Information about Version Numbers follows:

Each version of the XML schemas and the corresponding business rules has a unique version number assigned. It is important to note the following principles regarding version numbers:

- Each information return’s schema version has an associated set of business rules with the same version number. This ensures that each updated schema version includes an updated set of business rules.
- The “Form n UpstreamDetailType” complex element includes a documentation element and dictionary entry name that identifies the form including the major and minor version numbers of the schema for each return type as well as the effective begin date for the XML Schema. For example, the “Form1095BUpstreamDetailType” from *IRS-Form1094-1095BTransmitterUpstreamMessage.xsd* file shown below identifies the schema version as v1.0 with an effective date of 2015-01-27.

```
<xsd:complexType name="Form1095BUpstreamDetailType">
  <xsd:annotation>
    <xsd:documentation>
      <Component>
        <DictionaryEntryNm>Form 1095-B Upstream Detail Type</DictionaryEntryNm>
        <MajorVersionNum>1</MajorVersionNum>
        <MinorVersionNum>0</MinorVersionNum>
        <VersionEffectiveBeginDt>2015-01-27</VersionEffectiveBeginDt>
        <VersionDescriptionTxt>Initial version</VersionDescriptionTxt>
        <DescriptionTxt>Form 1095-B - Health Coverage Information Return</DescriptionTxt>
      </Component>
    </xsd:documentation>
  </xsd:annotation>
</xsd:complexType>
```

Figure 4-6: 1095-B Upstream Detail Type

- Each business rule document’s version number identifies the version and effective begin date of the business rules.
- The “Active Validating Schema Version” specifies the business rules and schema version that will be used to validate an information return that has been received by IRS during a timeframe. This provides a mechanism for different versions to be accepted at the same time. It also enables an older version to be validated against a newer version’s set of schemas and business rules. IRS will publish all valid schema/business rule versions.

The active validating schema version will be the most recent schema version posted on the [Affordable Care Act Information Returns \(AIR\) Program](#) page. IRS will provide the “Start” dates when schemas are available in Production and AATS. These “Start” dates also represent when the latest schema posted becomes the active validating schema.

4.3.8 Validating Schema Versions

Throughout the year, multiple versions of XML Schemas and Business Rules may be posted to IRS.gov depending upon whether a change to the schema is major or minor; AIR may not require that the schema version used to submit the return data match the schema version used by AIR during validation. In general, there is one active validating schema version for each return type in a tax year. The Schema/Business Rules tables will include the

Start dates and End dates, if applicable, for AATS and Production. IRS strives to limit the number of schema and/or business rule revisions, especially after production opens. A QuickAlerts message is issued when a new version of the XML Schemas and Business Rules are posted on the [Affordable Care Act Information Returns \(AIR\) Program](#) page.

- Minor Schema Changes** - When IRS issues revised schemas for an information return type and changes the increment for the minor number, AIR continues to accept returns composed using previous schema versions. When the minor number is changed, IRS allows Software Developers to decide for themselves whether they need to use the new version or not based on what is included in their tax preparation software and what changes were made to the schemas.

Returns may be composed using previously published schema versions but IRS will only validate against the “active validating schema version” when the return is processed. For example:

If the current schema version is 1.0 and the schema change is minor, IRS will assign the new number 1.1. The active validating schema version is 1.1. AIR will continue to accept returns composed using version 1.0. However, all returns (whether composed with version 1.0 or 1.1) will be validated with the new version, 1.1.

- Major Schema Change** - When IRS issues revised schemas for an information return type and changes the increment for the major number, all returns must be composed by software using the new version. If information returns are composed using previously published schema versions, they will not validate against the active validating schema version when the return is processed and will be rejected.

For example, if the current version is 1.1 and IRS determines it can no longer accept information returns composed using schema version 1.1 (or v1.0), it will assign the new major number 2.0. The active validating schema version is 2.0. Returns submitted with 1.1 or earlier will be rejected for using an unsupported schema version.

Software Developers and Transmitters should select the applicable form type on the AIR Schemas and Business Rules page to get information about all active and prior year schemas and business rules used by the AIR Production and AATS.

Figure 4-7 is an example of the information provided regarding the schemas released for AIR:

Tax Year 2016 Forms 1094-B, 1094-C, 1095-B, and 1095-C

Version	Date Posted	AATS Dates	Production Dates
TY2016V3.3 Updates: 01/30/2017 - New posting added one additional file to schema package and business rule versions 2 and 3 were added for convenience.	10/13/2016	Start Date: 11/7/2016 End Date: TBD	Start Date: 01/17/2017 End Date: TBD

Figure 4-7: Example of AIR Schema Information

4.3.9 Example of Schema Versioning

The [Affordable Care Act Information Returns \(AIR\) Program](#) page provides information and technical guidance for Software Developers and Transmitters who are interested in developing software for AIR for Tax Years 2015, 2016 and 2017. Included are the XML Schemas, Business Rules, Release Memorandums and specific instructions.

- Note: When creating payload for prior year (TY2015, TY2016) data, please use the schemas and business rules that were in effect for that tax year. Do not use the current year schemas and rules. In addition, do not mix or combine tax years within the same submission or the same transmission. Transmitters should use the latest schema package Filing Season (FS) 2018 (TY2017) Manifest schema to generate A2A SOAP message or the UI Manifest file regardless of which tax year is being submitted.

Below is a sample of the AIR Forms XML Schemas Versioning:

```
<xsd:complexType name="Form1094BUpstreamDetailType">
  <xsd:annotation>
    <xsd:documentation>
      <Component>
        <DictionaryEntryNm>Form 1094B Upstream Detail Type</DictionaryEntryNm>
        <MajorVersionNum>1</MajorVersionNum>
        <MinorVersionNum>0</MinorVersionNum>
        <VersionEffectiveBeginDt>2014-08-20</VersionEffectiveBeginDt>
        <VersionDescriptionTxt>Initial version</VersionDescriptionTxt>
        <DescriptionTxt>Upstream Transmission detail for 1094B Forms.</DescriptionTxt>
      </Component>
    </xsd:documentation>
  </xsd:annotation>
</complexType>
```

```
<xsd:complexType name="Form1095BUpstreamDetailType">
  <xsd:annotation>
    <xsd:documentation>
      <Component>
        <DictionaryEntryNm>Form 1095B Upstream Detail Type</DictionaryEntryNm>
        <MajorVersionNum>1</MajorVersionNum>
        <MinorVersionNum>0</MinorVersionNum>
        <VersionEffectiveBeginDt>2014-11-04</VersionEffectiveBeginDt>
        <VersionDescriptionTxt>Initial version</VersionDescriptionTxt>
        <DescriptionTxt>Form1095-B (Issuer) Info Return - Health Insurance Coverage
      </Component>
    </xsd:documentation>
  </xsd:annotation>
</complexType>
```

```
<xsd:complexType name="Form1094CUpstreamDetailType">
  <xsd:annotation>
    <xsd:documentation>
      <Component>
        <DictionaryEntryNm>Form 1094C Upstream Detail Type</DictionaryEntryNm>
        <MajorVersionNum>1</MajorVersionNum>
        <MinorVersionNum>0</MinorVersionNum>
        <VersionEffectiveBeginDt>2014-08-20</VersionEffectiveBeginDt>
        <VersionDescriptionTxt>Initial version</VersionDescriptionTxt>
        <DescriptionTxt>Employer - Upstream Transmission detail for 1094C Forms.</Descri
      </Component>
    </xsd:documentation>
  </xsd:annotation>
</complexType>
```



```

<xsd:complexType name="Form1095CUpstreamDetailType">
  <xsd:annotation>
    <xsd:documentation>
      <Component>
        <DictionaryEntryNm>Form 1095C Upstream Detail Type</DictionaryEntryNm>
        <MajorVersionNum>1</MajorVersionNum>
        <MinorVersionNum>0</MinorVersionNum>
        <VersionEffectiveBeginDt>2014-11-04</VersionEffectiveBeginDt>
        <VersionDescriptionTxt>Initial version</VersionDescriptionTxt>
        <DescriptionTxt>Form1095-C (Employer) Info Return - Employer-Provided Health Insuranc
      </Component>
    </xsd:documentation>
  </xsd:annotation>
</complexType>

```

Figure 4-8: Schema Samples for AIR Forms

4.4 Threat Mitigations in AIR Transmissions

Information Submission Services (ISS) will only accept XML files and attachments. Each file, message and/or attachment transmitted through the ISS-A2A or ISS-UI channels will be checked for threats before being routed to AIR back-end systems. In the event the system detects a threat in the Transmission File, the following steps will be taken:

- ISS will perform threat mitigation and initial validation on authorized connections.
- The Transmission will be rejected and a fault code (TPE Error) response will be returned.
- The Transmitter must remove the infected data and then retransmit the file.

```

<?xml version="1.0" encoding="UTF-8"?>
<soapenv:Envelope xmlns:soapenv="http://schemas.xmlsoap.org/soap/envelope/">
  <soapenv:Body>
    <soapenv:Fault>
      <faultcode>soapenv:Client</faultcode>
      <faultstring>We were unable to authenticate your credentials. Please review the information
about digital certificates included in Section 5 of the AIR Submission Composition and Reference
Guide located at https://www.irs.gov/for-Tax-Pros/Software-Developers/Information-Returns/Affordable-Care-Act-Information-Return-AIR-Program, ensure that the credentials are
valid, and try again.</faultstring>
      <detail>
        <errorcode>TPE1128</errorcode>
        <uniqueTransmissionID/>
      </detail>
    </soapenv:Fault>
  </soapenv:Body>
</soapenv:Envelope>

```

Figure 4-9: Sample of an A2A Channel Fault Message

ACA Transmission File Upload

 1 error has occurred. See below for more information. If the problem continues, please [contact us](#).

[TPE1201] Our system has detected a potential threat in the Form file and it cannot be transmitted. This may be due to malformed XML. Please review the XML standards outlined in Section 3 of the AIR Submission Composition and Reference Guide located [here](#), correct any issues on the Form file, and try again.

Figure 4-10: Sample of a UI Channel Fault Message

Table 4-5 below defines fault codes and messages from the ISS.

Table 4-5: List of Fault Codes (TPE Errors) for Tax Years 2015, 2016 and 2017

Fault Code	Service Leg	Reason	Channel	ISS Fault Message
TPE1001	Request	Message Delivery Failure	A2A	We are experiencing a technical issue. Please try your request again later. We apologize for the inconvenience.
			UI	We are experiencing a technical issue [Error Code 6052]. Please try your request again later. We apologize for the inconvenience.
TPE1102	Request	Service Window Closed	A2A	The requested service is not available at this time. Please resubmit during normal operation hours.
			UI	*Error not applicable to ISS-UI
TPE1104	Request	Request is not compliant	A2A	The request is not compliant with web service policy requirements. Please review the transmission instructions outlined in Section 5 of the <i>Pub 5258, AIR Submission Composition and Reference Guide</i> . Correct any issues, and try again.
			UI	We are experiencing a technical issue [Error Code 6064]. Please try your request again later. We apologize for the inconvenience.
TPE1105	Request	XML is not well-formed	A2A	The message was not formatted properly and/or cannot be interpreted. Please review the XML standards outlined in Section 3 of the <i>Pub 5258, AIR Submission Composition and Reference Guide</i> . Correct any issues, and try again.
			UI	[TPE1105] Our system has detected a potential threat in the Manifest file you are attempting to transmit and it cannot be transmitted. This may be due to malformed XML. Please review the XML standards outlined in Section 3 of the <i>Pub 5258, AIR Submission Composition and Reference Guide</i> . Correct any issues on the Manifest file, and try again.

Fault Code	Service Leg	Reason	Channel	ISS Fault Message
TPE1106	Request	SOAP message does not conform to WSDL	A2A	The message did not match our current WSDL and/or schema. Please see the Fault Details information below for the particular element(s) our system has detected a potential issue with. Please review the published WSDLs and schemas located on the AIR Program page. Correct any issues, and try again.
			UI	[TPE1106] The Manifest file does not match our current schema. In particular, our system has detected a potential issue with the following element(s): <Element1>, <Element2>, <Element3>, and others. Please review the published schemas on the AIR Program page. Correct any issues, and try again.
TPE1107	Request	Message exceeds maximum size limit of 100 MB	A2A (Request message exceeds the 100 MB maximum size limit. Please review the XML file standards outlined in Section 3 of the <i>Pub 5258, AIR Submission Composition and Reference Guide</i> . Correct any issues with the request, and try again.
			UI	[TPE1107] The Form file exceeds the 100 MB size limit. Please review the XML file standards outlined in Section 3 of the <i>Pub 5258, AIR Submission Composition and Reference Guide</i> . Correct any issues with the request, and try again.
TPE1108	Request	Potential Code Injection Threat	A2A	Our system has detected a potential threat in the transmission and it cannot be transmitted. Please review the XML standards outlined in Section 3 of the <i>Pub 5258, AIR Submission Composition and Reference Guide</i> . Correct any issues, and try again.
			UI	[TPE1108] Our system has detected a potential threat in the Manifest file and it cannot be transmitted. Please review the XML standards outlined in Section 3 of the <i>Pub 5258, AIR Submission Composition and Reference Guide</i> . Correct any issues on the Manifest file, and try again.
TPE1109	Request	Potential SQL Injection Threat	A2A	Our system has detected a potential threat in the transmission and it cannot be transmitted. Please review the XML standards outlined in Section 3 of the <i>Pub 5258, AIR Submission Composition and Reference Guide</i> . Correct any issues, and try again.

Fault Code	Service Leg	Reason	Channel	ISS Fault Message
			UI	[TPE1109] Our system has detected a potential threat in the Manifest file and it cannot be transmitted. Please review the XML standards outlined in Section 3 of the <i>Pub 5258, AIR Submission Composition and Reference Guide</i> . Correct any issues on the Manifest file, and try again.
TPE1110	Request	Potential Document Structure Threat	A2A)	Our system has detected a potential threat in the transmission and it cannot be transmitted. Please review the XML standards outlined in Section 3 of the <i>Pub 5258, AIR Submission Composition and Reference Guide</i> . Correct any issues, and try again.
			UI	[TPE1110] Our system has detected a potential threat in the Manifest file and it cannot be transmitted. Please review the XML standards outlined in Section 3 of the <i>Pub 5258, AIR Submission Composition and Reference Guide</i> . Correct any issues on the Manifest file, and try again.
TPE1112	Request	HTTP Compression Failure	A2A	The request message must be sent using HTTP compression (RFC 1952 - GZIP). Please review the transmission instructions outlined in Section 5 of the <i>Pub 5258, AIR Submission Composition and Reference Guide</i> . Correct any issues, and try again.
			UI	*Error not applicable to ISS-UI
TPE1114	Request	Message not MTOM encoded	A2A	The request message must be MTOM encoded. Please review the transmission instructions outlined in Section 5 of the <i>Pub 5258, AIR Submission Composition and Reference Guide</i> . Correct any issues, and try again.
			UI	*Error not applicable to ISS-UI
TPE1115	Request	Unable to decode MTOM encoded request message	A2A	We are experiencing a technical issue. Please try your request again later. We apologize for the inconvenience.
			UI	*Error not applicable to ISS-UI
TPE1118	Request	UTF-8 BOM encoding in the Manifest file and cannot be interpreted	UI only	Our system has detected UTF-8 BOM encoding in the Manifest file and cannot be interpreted. Please review the XML standards outlined in Section 10 of the <i>Pub 5258, AIR Submission Composition and Reference Guide</i> . Correct any issues, and try again.

Fault Code	Service Leg	Reason	Channel	ISS Fault Message
TPE1122	Request	Invalid WS Security Signature	A2A	The WS Security Header in the message is invalid. Please review the transmission instructions outlined in Section 5 of the <i>Pub 5258, AIR Submission Composition and Reference Guide</i> . Correct any issues, and try again.
			UI	*Error not applicable to ISS-UI
TPE1126	Request	Failed to connect to the Authentication Policy Server	A2A	We are experiencing a technical issue. Please try your request again later. We apologize for the inconvenience.
			UI	We are experiencing a technical issue [Error Code 6064]. Please try your request again later. We apologize for the inconvenience.
TPE1127	Request	Missing credentials in HTTP request	A2A	Message not formatted properly and is missing HTTP credentials. Please check message and try again.
			UI	We are experiencing a technical issue [Error Code 6064]. Please try your request again later. We apologize for the inconvenience.
TPE1128	Request	Failed to authenticate with the Authentication Policy Server	A2A	We were unable to authenticate your credentials. Please review the information about digital certificates included in Section 5 of the <i>Pub 5258, AIR Submission Composition and Reference Guide</i> . Ensure that the credentials are valid, and try again.
			UI	We are experiencing a technical issue [Error Code 6064]. Please try your request again later. We apologize for the inconvenience.
TPE1129	Request	Failed to authorize with the Authentication Policy Server	A2A	We were unable to authorize your credentials. Please review the information about digital certificates included in Section 5 of the <i>Pub 5258, AIR Submission Composition and Reference Guide</i> . Ensure that the credentials are valid, and try again.
			UI	We are experiencing a technical issue [Error Code 6064]. Please try your request again later. We apologize for the inconvenience.
TPE1130	Request	Request contains Invalid Test File Code value	A2A	Our system has detected an error with the Test File Code. Please check the message and try again. Please note that the Test File Code value of 'T' is used for AATS transmissions and the Test File Code value of 'P' is used for transmissions intended for IRS compliance processing.
			UI	[TPE1130] Our system has detected an error with the Test File Code of your Manifest file. Please check the file and try again. Please note that the Test File Code value of 'T' is used for AATS transmissions and the Test File Code value of 'P' is used for transmissions intended for IRS compliance processing.

Fault Code	Service Leg	Reason	Channel	ISS Fault Message
TPE1131	Request	Request message UTID is either missing or invalid	A2A	Our system has detected an error with the Unique Transmission ID. Please review the UTID format outlined in Section 5 of the <i>Pub 5258, AIR Submission Composition and Reference Guide</i> . Correct any issues, and try again.
			UI	[TPE1131] Our system has detected an error with the Unique Transmission ID of your Manifest file. Please review the UTID format outlined in Section 5 of the <i>Pub 5258, AIR Submission Composition and Reference Guide</i> . Correct any issues on the Manifest file, and try again.
TPE1201	Request	Attachment is malformed	A2A	The attachment was not formatted properly and/or cannot be interpreted. Please review the XML standards outlined in Section 3 of the <i>Pub 5258, AIR Submission Composition and Reference Guide</i> . Correct any issues, and try again.
			UI	[TPE1201] Our system has detected a potential threat in the Form file and it cannot be transmitted. This may be due to malformed XML. Please review the XML standards outlined in Section 3 of the <i>Pub 5258, AIR Submission Composition and Reference Guide</i> . Correct any issues on the Form file, and try again.
TPE1203	Request	Potential Code Injection in Attachment	A2A	Our system has detected a potential threat in the request message attachment. Please review the XML standards outlined in Section 3 of the <i>Pub 5258, AIR Submission Composition and Reference Guide</i> . Correct any issues, and try again.
			UI	[TPE1203] Our system has detected a potential threat in the Form file and it cannot be transmitted. Please review the XML standards outlined in Section 3 of the <i>Pub 5258, AIR Submission Composition and Reference Guide</i> . Correct any issues on the Form file, and try again.
TPE1204	Request	Potential SQL Injection in Attachment	A2A	Our system has detected a potential threat in the request message attachment. Please review the XML standards outlined in Section 3 of the <i>Pub 5258, AIR Submission Composition and Reference Guide</i> . Correct any issues, and try again.

Fault Code	Service Leg	Reason	Channel	ISS Fault Message
			UI	[TPE1204] Our system has detected a potential threat in the Form file and it cannot be transmitted. Please review the XML standards outlined in Section 3 of the <i>Pub 5258, AIR Submission Composition and Reference Guide</i> . Correct any issues on the Form file, and try again.
TPE1205	Request	Potential Document Structure Threat in Attachment	A2A	Our system has detected a potential threat in the request message attachment. Please review the XML standards outlined in Section 3 of the <i>Pub 5258, AIR Submission Composition and Reference Guide</i> . Correct any issues, and try again.
			UI	[TPE1205] Our system has detected a potential threat in the Form file and it cannot be transmitted. Please review the XML standards outlined in Section 3 of the <i>Pub 5258, AIR Submission Composition and Reference Guide</i> . Correct any issues on the Form file, and try again.
TPE1206	Request	Extra attachment(s)	A2A	The request message contains more than one attachment. Please review the transmission instructions outlined in Section 5 of the <i>Pub 5258, AIR Submission Composition and Reference Guide</i> . Resubmit with only one attachment.
			UI	*Error not applicable to ISS-UI
TPE1207	Request	Missing attachment(s)	A2A	The request message is missing an attachment. Please review the transmission instructions outlined in Section 5 of the <i>Pub 5258, AIR Submission Composition and Reference Guide</i> . Add an attachment to the request, and resubmit.
			UI	We are experiencing a technical issue [Error Code 6064]. Please try your request again later. We apologize for the inconvenience.
TPE1208	Request	UTF-8 BOM encoding in the Form file and cannot be interpreted	UI and A2A	Our system has detected UTF-8 BOM encoding in the Form file and cannot be interpreted. Please review the XML standards outlined in Section 10 of the <i>Pub 5258, AIR Submission Composition and Reference Guide</i> . Correct any issues, and try again
TPE2001	Response	Consumer is unreachable	A2A	Unable to deliver response message to service consumer.
			UI	*Error not applicable to ISS-UI
TPE2111	Response	Unable to parse Receipt ID from Receipt message using XPath	A2A	Parse Receipt ID from Response message using XPath.
			UI	We are experiencing a technical issue with the receipt [Error Code 6064]. Please try your request again later. We apologize for the inconvenience.
TPE2112	Response	Unable to	A2A	Parse Timestamp from Response Message using XPath.

Fault Code	Service Leg	Reason	Channel	ISS Fault Message
		parse timestamp from Receipt message using XPath	UI	We are experiencing a technical issue with the receipt [Error Code 6064]. Please try your request again later. We apologize for the inconvenience.
TPE2113	Response	Unable to parse UTID from Receipt message using XPath	A2A	Parse UTID from Response Message using XPath.
			UI	We are experiencing a technical issue with the receipt [Error Code 6064]. Please try your request again later. We apologize for the inconvenience.
TPE2114	Response	Unable to parse Error Code from Receipt message using XPath	A2A	Parse Error Code from Response Message using XPath.
			UI	We are experiencing a technical issue with the receipt [Error Code 6064]. Please try your request again later. We apologize for the inconvenience.
TPE2115	Response	Unable to parse Error Message from Receipt message using XPath	A2A	Parse Error Message from Response Message using XPath.
			UI	We are experiencing a technical issue with the receipt [Error Code 6064]. Please try your request again later. We apologize for the inconvenience.
TPE2201	Response	There is an excess number of attachments in the response	A2A	We are experiencing a technical issue. Please try your request again later. We apologize for the inconvenience.
			UI	We are experiencing a technical issue with the receipt [Error Code 6064]. Please try your request again later. We apologize for the inconvenience.
TPE2202	Response	The attachment in the response exceeded maximum size limit	A2A	We are experiencing a technical issue. Please try your request again later. We apologize for the inconvenience.
			UI	We are experiencing a technical issue with the receipt [Error Code 6064]. Please try your request again later. We apologize for the inconvenience.

4.4.1 Threat Mitigation through ISS-UI

If an error has occurred upon upload of the Manifest and Form Data File, the user will be returned to the upload page with an error marked in red. Examples of the upload page and upload error page are shown below in Figures 4-11 and 4-12.

ACA Transmission File Upload

Upload Manifest

Browse for your Manifest file in XML format.

Note: Only one Manifest file may be selected to coincide with this transmission.

Manifest File

Upload Form

Browse for your Form file containing Form 1094B and all associated 1095Bs or Form 1094C and all associated 1095Cs in XML format. Once you have selected your files select "Transmit" to process the transmission.

Note: Only one Form file may be selected to coincide with this transmission. Your total transmission file size may not exceed 100MB and may only include XML file types.

Form File

Transmission

Once you click "Transmit", you will NOT be able to cancel your transmission.

If your file is successfully received after clicking "Transmit", a confirmation page will appear that contains the Receipt ID for this transmission. It is recommended that you save your Receipt ID in a secure location. If there was a problem with your file, an error page will be shown. Please correct the problem and try your transmission again.

Note: Due to file size limitations, please allow sufficient time for larger Form files to be transmitted.

Figure 4-11: Example of UI Upload Page

If an error has occurred upon submission status requests, the Transmission Status Details page will display an error table depicting the error codes and corresponding error details. An example of the transmission status page is shown below in Figure 4-12.

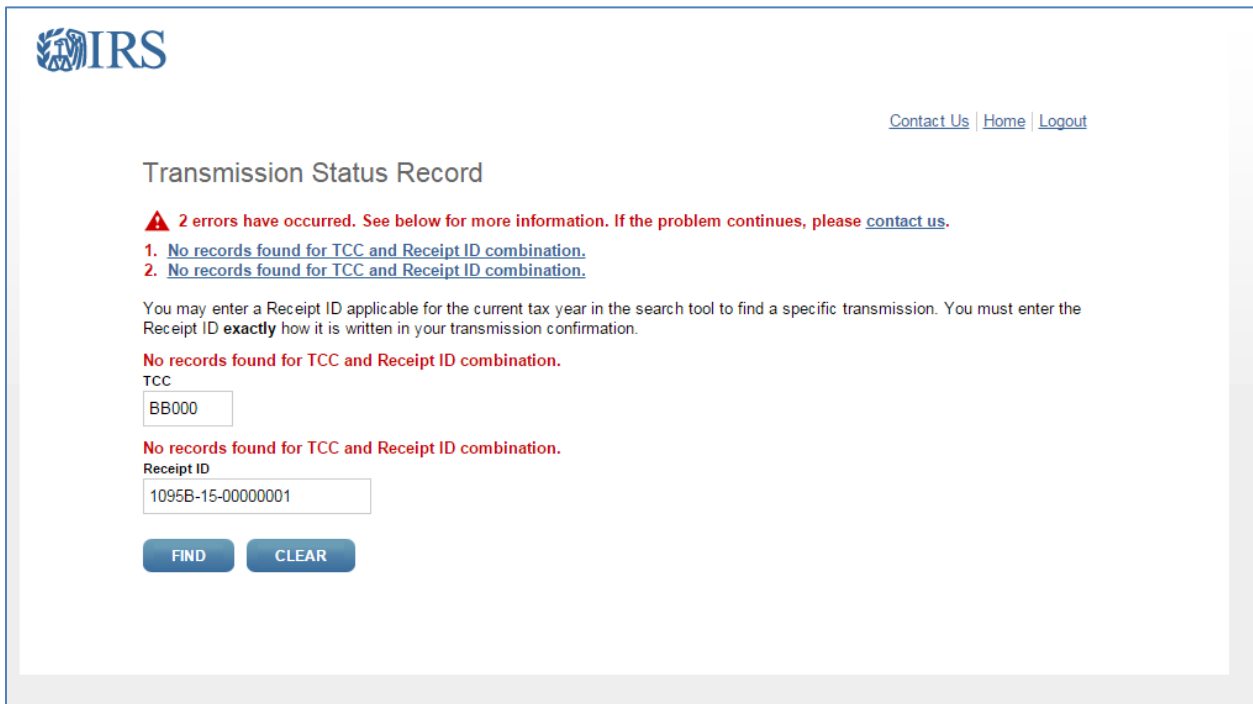

Figure 4-12: UI Upload Page Showing the Search Error

4.4.2. Threat Mitigation through ISS-A2A

ISS-A2A will perform threat mitigation and initial validation on authorized connections. ISS-A2A will return a fault if a transmission contains a threat, if a transmission fails initial validation, or if a connection with the endpoint cannot be established and reject the transmission.

Faults differ from errors – a fault is an issue during transmission, whereas an error is the result of business rules processing failure. The Fault Generation process is common to each of ISS-A2A process flows. Fault messages generated to ISS-A2A are always routed to the Service Consumer via a SOAP message.

5 Validating the Transmission and Return Data

This section explains how the AIR System will perform validations of the transmission and return data via Schema validations, Transmission Header and Manifest validations, and Business Rule checks.

When AIR receives a transmission, the following tasks are executed in order:

- a) The Receipt ID and Timestamp are generated
- b) Basic Manifest validations such as TCC validations are performed in synchronous session
- c) If any conditions fails with the TCC or Software ID, AIR will stop processing
- d) The Receipt ID, Timestamp, and Unique Transmission ID (A2A only) are returned to the Transmitter
- e) The Form Data File attached to the transmission is read and written to persistent storage
- f) Verify “Attachment Byte Size Number” by calculation and comparison
- g) Verify that the UUID extracted from the ACA Business Correlation ID is unique for the Transmitter Control Code (TCC) extracted from the ACA Business Correlation ID
- h) Verify Transmission Type Code, Tax Year and Vendor Information
- i) Verify duplicate file validation
- j) Schema Validation is executed in the Form Data File

- k) The Form Data File is queued for processing against the AIR Business Rules
- l) Errors identified during processing against the AIR Business Rules are written to the AIR database and inserted into an Error Data File that will be returned to the Transmitter in the Acknowledgement

When errors are identified with the transmission or AIR cannot read or write the Form Data File to persistent storage, the transmission will be rejected and the appropriate error code and description will be returned to the Transmitter in the SOAP Response message.

If the Form Data File fails Schema validation, the transmission will be rejected. The appropriate error code and description relevant to Schema validation will be returned when the Transmitter retrieves the Acknowledgement for the respective transmission.

When business rule errors are identified during processing of the Form Data File, AIR will record the error codes and descriptions and return those errors in the Error Data File attached to the Acknowledgement SOAP Response message as an MTOM encoded attachment.

Note: When entering a foreign address, AIR will only accept certain foreign country codes which are aligned with the codes that the Modernized e-File (MeF) application accepts. The list of allowable foreign country codes that IRS accepts is found at the following link: www.irs.gov/countrycodes.

5.1 Transmission Validation

This section describes the checks that are made on the transmission and the errors that will be returned to the Transmitter if the transmission is rejected before it can be saved for further processing.

Table 5-1: AIR Error Categories

Error Prefix	General Description	Severity	Action
AIRER (File Read Error)	Unable to process request – cannot read or persist XML File	Transmission Rejected	Transmitter notified via SOAP Response to transmission message Transmitter resolves on read error, AIR resolves on write error
HEADER-XXX MANIFEST-XXX (TY2016+) AIRMF (TY2015) (Manifest Validation Error)	Error occurred validating the transmission Manifest or Header	Transmission Rejected	Transmitter notified via the Acknowledgement Transmitter resolves
AIRSH (XML Schema Validation Error)	Error occurred during XML Schema Validation – missing data elements or schema not well formed	Transmission Rejected	Transmitter notified via the Acknowledgement Transmitter resolves
HEADER-XXX MANIFEST-XXX (TY2016+) AIRMF (TY2015) (Duplicate File)	The XML File is a duplicate	Transmission Rejected	Transmitter notified via the Acknowledgement Transmitter resolves

Error Prefix	General Description	Severity	Action
HEADER-XXX MANIFEST-XXX, 1095B-XXX, 1094C- XXX,1095C-XXX (TY2016+) AIREX, AIRMF (TY2015) (Correction validation failure)	Correction Information provided is invalid	Transmission Rejected	Transmitter notified via the Acknowledgement Transmitter resolves
SHARED-XXX 1094B-XXX, 1095B- XXX, 1094C- XXX,1095C-XXX (TY2016+) AIRTN (TY2015) (TIN Validation Error)	TIN and Name do not match IRS records	Transmission Accepted with Error	Transmitter notified via the Acknowledgement Transmitter is expected to correct the data and send correction record to IRS
SHARED-XXX 1094B-XXX, 1095B- XXX, 1094C- XXX,1095C-XXX (TY2016+) AIRBR (TY2015) (Business Rule Validation Error)	Error occurred while processing the record against the business rules	Transmission Accepted with Error	Transmitter notified via the Acknowledgement Transmitter is expected to correct the data and send correction record to IRS

5.1.1 Missing or Multiple Attachments

Checks for missing or multiple attachments occur during the transmission synchronous process. AIR first validates that one and only one Form Data File is attached to the transmission. If there are no files attached, AIR will reject the transmission and return the appropriate error code and error description. If there is more than one XML Form Data File attached to the transmission, AIR will reject the transmission and return the appropriate error code and error description.

5.1.2 Error Reading or Persisting the Form Data File

Errors reading or persisting the Form Data File occurs during the transmission synchronous process. AIR extracts the Form Data File from the MTOM encoded attachment, reads the file and stores the file to persistent storage. If AIR cannot read, or persist, the Form Data File, AIR will reject the transmission and return an error code with a prefix **AIRER**.

5.1.3 Manifest Verification Failure

Manifest verification checks occur after receipt processing (reading and persisting the XML Form Data File).

AIR will perform the following checks against the data included in the Manifest and return any errors found when the Transmitter retrieves the Acknowledgement for the transmission:

- Verify that the Test File Indicator is set to 'P' (PROD)

- Verify that the Transmitter Control Code (TCC – included in the ACA Business Correlation ID) is valid, in the “Active” status, and authorized to transmit the Information Returns included in the transmission (**Note:** If the transmission is rejected with Header-005 or Header-006 (SysError 1 or 2) wait 24 hours, then retransmit.)
- Verify that the TCC is authorized (Roles - Issuer or Transmitter) to transmit the forms in the transmission and that the forms are in Production ‘P’ status
- Verify that the Software ID is authorized for PROD and in the “P” status
- If any conditions fail in TCC or Software ID, AIR will stop processing
- Verify “Attachment Byte Size Number” by calculation and comparison
- Verify that the UUID extracted from the ACA Business Correlation ID is unique for the Transmitter Control Code (TCC) extracted from the ACA Business Correlation ID
- Verify Transmission Type Code , Tax Year and Vendor Information
- Verify duplicate file validation based on checksum number and status of the transmission

Note: *If an error occurs during TCC authorizations, processing stops at that point for security reasons and the remainder of the Manifest is not validated.*

If the above verifications fail, AIR will reject the transmission and return a Business Rule error with a prefix MANIFEST or HEADER for TY2016 forms & beyond or an Error code prefixed with AIRMF for TY2015 forms with the following two exceptions, where these Business Rules are returned rather than an Error Code:

- **MANIFEST-001:** If Manifest 'PriorYearDataInd' has a choice of "Yes" indicated, then 'PaymentYr' must be equal to the Processing Year minus two or more years
- **MANIFEST-002:** If Manifest 'PriorYearDataInd' has a choice of "No" indicated, then 'PaymentYr' must not be equal to the Processing Year minus two or more

5.1.4 Duplicate XML File Detected

Duplicate file checks occur after the Transmitter has successfully submitted the transmission to IRS. AIR checks the computed SHA256 Checksum and the size of the Form Data File against previously processed Form Data Files submitted by the respective TCC. If the checksum that AIR identified from the Form Data File on persistent storage match a Form Data File previously transmitted by that TCC, the file will be rejected as duplicate and return a corresponding duplicate error code with prefix MANIFEST for TY2016 forms and beyond and AIRMF for TY2015 forms.

- The Form Data file will not be identified as duplicate if the previously submitted file status is “REJECTED”

5.1.5 XML File Schema Validation Failure

XML Schema Validation occurs after the Transmitter has successfully submitted the transmission to IRS. IRS recommends each return be run against a validating parser prior to being submitted to IRS. This pre-validation is intended to identify the majority of potential error conditions and minimize the chance of receiving errors. A validating parser compares the XML document to the defined elements and attributes of the schemas to ensure a well-formed document that adheres to the XML Schema is transmitted to IRS. **Schemas provide the basic definition for elements (i.e., field length, data type, prescribed patterns, enumerations, etc.).** Data integrity depends on each data element complying with the data format specifications. If the ACA Information Return preparation software uses IRS-defined XML schemas to create the XML information return, there should be no data format errors in the return. The AIR System verifies this by validating each return in the transmission file against the schemas.

The information return documents must conform to the version of the XML schema they specify. AIR conducts XML schema validation on the Form Data File before processing. Any schema validation failures are reported back to the originating entity. If the XML does not conform to the XML Schema (missing required elements or XML not well formed), AIR will reject the transmission and return an error code with a prefix **AIRSH**.

The Error Data File contains the error codes, the error descriptions, and the XPath reference to the element found to be in error.

Effective January 2017, the AIR schemas will not allow empty or null values within schema tags. All data elements present by virtue of an opening and a closing tag must contain a value. Empty or null tags (even for optional data elements) will result in a transmission rejection. Do not include tags for optional data elements that are empty.

Note: When an error is found during schema validation, processing stops when schema validation completes. No Business rules will be applied to the submission, and if the error is found in the Manifest, the submission (xml archive) will not be schema validated either.

Note: *It is important that transmission files be run through a validating parser to find any errors before transmitting.*

Table 5-2 below includes notional samples of schema validation business rules.

Table 5-2: Schema Validation Business Rules

Error Code	Error Description Text	Error Category	Action
AIRSH100	XML Schema Validation Failed - not well formed or missing required elements.	XML Error	Transmission rejected
AIRSH101	XML Schema Validation Failed in Manifest	XML Error	Transmission rejected

(Note: AIRSH100 and AIRSH101 occurred when element schema definition does not follow the pattern. For example: type, length, spaces, etc., or missing a required element)

5.1.6 Business Rule Errors

Business rule checks occur after the Transmitter has successfully submitted the transmission to IRS.

To the extent possible, the AIR business rules have been standardized across all information returns currently available in AIR. As additional information returns migrate to the modernized architecture, the associated business rules for those returns will be rewritten to maintain the standardization across all form types.

The following error information will be returned to the Transmitter when IRS identifies errors associated with a business rule for **TY2015** forms:

- AIREX, AIRMF Validate correction information with the following two exceptions:
 - **MANIFEST- 001:** If Manifest 'PriorYearDataInd' has a choice of "Yes" indicated, then 'PaymentYr' must be equal to the Processing Year minus two or more years
 - **MANIFEST- 002:** If Manifest 'PriorYearDataInd' has a choice of "No" indicated, then 'PaymentYr' must not be equal to the Processing Year minus two or more
- AIRTN500 –TIN and Name provided do not match IRS database

- AIRBR400 – AIRBR499 (1094-B data consistency check)
- AIRBR500 – AIRBR599 (1094-B data cardinality check)
- AIRBR600 – AIR BR699 (1095-B data consistency check)
- AIRBR700 – AIRBR799 (1095-B data cardinality check)
- AIRBR800 – AIRBR899 (1094-C data consistency check)
- AIRBR900 – AIRBR999 (1094-C data cardinality check)
- AIRBR1000 – AIRBR1099 (1095-C data consistency check)
- AIRBR1100 – AIRBR1199 (1095-C data cardinality check)

Beginning with Tax Year 2016 submissions, error files returned to Transmitters will show exactly which business rules were violated by the transmission rather than displaying which error codes were triggered. These rules will have a one-to-one relationship to the rules posted on the [Affordable Care Act Information Returns \(AIR\) Program](#) page. The change is designed to help Transmitters better understand the exact nature of the business rule violation.

The following error information will be returned to the Transmitter when IRS identifies errors associated with a business rule for TY2016 and beyond forms:

- a. Header level: HEADER-XXX-XX
- b. Manifest level: MANIFEST-XXX-XX
- c. Form level: 1094B-XXX-XX, 1095B-XXX-XX, 1094C-XXX-XX, 1095C-XXX-XX, SHARED - XXX

Note: The first “XXX” is sequential numbering of Business Rule; second “XX” is version number of the Business Rule (as needed; left off for first version)

New for Tax Year 2017, Form level rules also include Shared rules for some of the Covered Individual Group on Forms 1095-B and 1095-C. The shared rules are displayed as Shared-XXX.

Certain business rules (those with a severity of “Report Error and Reject if Over Threshold”) may cause a rejection of the entire submission, if violated in more instances than the threshold allows. If this happens, the Transmitter will receive an Error Data File containing all the rules that were violated plus a generic “Threshold” error for each threshold that was exceeded. It is the responsibility of the Transmitter to correct all business rule errors and retransmit a replacement. Business rules for the AIR forms are posted to [Affordable Care Act Information Returns \(AIR\) Program](#) page.

6 Acknowledgement Files

Once the transmission is received, the Form Data File is read and written to persistent storage, and checks are made on the Transmission Manifest Data, the Receipt ID, Timestamp, and Unique Transmission ID are returned to the Transmitter as part of the synchronous session. The AIR System responds with a receipt for the transmission or an error explaining what was wrong, if anything, with the transmission. The XML Form Data File is then queued for processing within AIR.

When AIR receives a status request, an Acknowledgement file is generated indicating the status of the transmission (**Processing, Partially-Accepted, Accepted, Accepted with Errors, Rejected, and Not Found**) and is available for the Transmitter to retrieve. Transmitters should wait at least 10 minutes after the “Receipt ID” is provided to request the Acknowledgement for a transmission. The Acknowledgement includes an uncompressed native XML Error Data File that contains errors found during validation. **If there are no errors found during validation, the**

Error Data File is not included in the Acknowledgement and the transmission processing status will be "Accepted".

Note: The XML Error Data File attached to the Acknowledgement is constrained to 200 MB. If the number of validation errors identified result in the XML File exceeding the 200 MB constraint, the file will be truncated and a message will be inserted at the end of the file indicating that the file was truncated.

*During peak processing periods, the Acknowledgement may not be ready for several hours, and can take up to 7 days after the “Receipt ID” is provided.

The Transmission Acknowledgement will include:

- Transmitter Control Code
- Shipment Record Number for the transmission
- Unique Transmission ID
- Form Type Code
- Timestamp
- Submission Status Code: Accepted, Rejected, Processing, Partially Accepted, Accepted with Errors, Not Found
- Error Message Detail
 - Error Message Code (Error Code or Business Rule number)
 - Error Message Text (Error Code or Business Rule Description)
 - XPathContent (link to schema error AIRSHXXX location within the transmitted Form Data File.)
Note: The XPath identifies the specific data element and instance in an enumerated group, if applicable, causing the violation.
- Document System File Name
- Checksum Augmentation Number (SHA256) – if a file is attached to the Acknowledgement
- Attachment Byte Size Number

Refer to the items in the Acknowledgement Schema (in the *IRS-Form1094-1095BCTransmitterRespMessage.xsd* file), for all of the items that can be included in the information return Acknowledgement.

6.1 Acknowledgement Schema

AIR returns an Error Data File with the Acknowledgement when errors are found in the transmission. The same data file is shared by all ACA Information Returns (Forms 1094/1095-B and 1094/1095-C). The table below explains some of the elements in the Acknowledgement:

Table 6-1: AIR Forms Acknowledgement Schema Elements

Element Name	Explanation
UniqueTransmissionId	The UTID AIR derived from the ACA Business Correlation ID (See Section 3.2 of this document)
TransmitterControlCd	The Transmitter Control Code that submitted the transmission – must match the TCC provided in the Acknowledgement request

Element Name	Explanation
ShipmentRecordNum	A value computed by AIR TCC+2 character alphanumeric <ul style="list-style-type: none"> • A value computed by AIR – TCC+00 The two zeros appended to the TCC are static and constant in the ShipmentRecordNum for all transmissions processed through AIR
ReceiptId	The Receipt ID returned to the Transmitter when this transmission was submitted to IRS
FormTypeCd	The Form Type included in the transmission
Timestamp	A Timestamp when the Acknowledgement was provided to the Transmitter
SubmissionStatusCd	One of: <ul style="list-style-type: none"> • Accepted • Rejected • Processing • Partially Accepted • Accepted with Errors • Not Found
ErrorMessageDetail	A specific error code and error description of the error for TY2015 forms and Business Rule number and description for TY2016 & beyond forms. AIRER & AIRSH for all tax years.
DocumentSystemFileNm	The name of the uncompressed native XML file in the MTOM encoded attachment – applies only when a file is attached
ChecksumAugmentationNum	The SHA256Type checksum value computed against the uncompressed native XML file in the MTOM encoded
AttachmentByteSizeNum	The Byte size of the uncompressed native XML file in the MTOM encoded attachment – applies when a file is attached

6.2 Retrieving Acknowledgements

Transmitters must have an active IRS account and been approved to transmit ACA Information Returns. See Section 2 above for information about obtaining an account and applying for an ACA Information Return TCC. The AIR System will allow the Transmitter to either transmit submissions to IRS and/or retrieve Acknowledgements for those transmissions from IRS. The **Acknowledgement File** consists of the status of the transmission and contains details such as any business rules validation errors, and TIN validation failures that were found when the XML transmission file (Form Data File) is processed. The status of the transmission includes one of the following:

- **Accepted** (IRS has successfully processed and accepted the transmission: **No XML Error Data File or MTOM encoded attachment is included**)
- **Rejected** (IRS rejected the transmission as it could not be processed successfully: An XML Error Data File or MTOM encoded attachment may or may not be included)

- **Processing** (IRS has not completed processing the transmission: **No XML Error Data File or MTOM encoded attachment is included**)
- **Partially-Accepted** (IRS has successfully processed the transmission (**accepted and rejected one or more submissions contained in the transmission**): An XML Error Data file or MTOM encoded attachment may or may not be included)
 - No fatal errors were identified while processing the transmission metadata
 - At least one submission within the transmission was accepted (with or without errors)
 - At least one submission within the transmission was rejected as unusable data (exceeded threshold)
- **Accepted with Errors** (IRS has successfully processed and accepted the transmission with some errors: An XML Error Data file or MTOM encoded attachment is included containing the details)
- **Not Found** (The Receipt ID or the UTID in the request was not found: **No XML Error Data File or MTOM encoded attachment is included**)

The details of errors found when IRS processed the XML Form Data File are made available to the Transmitter via display on their web browser (UI channel) or are included in an XML Form Data File attached to the SOAP Response in an MTOM encoded attachment (A2A channel). If the error detail exceeds the 200 MB limit, the error reporting will be truncated and a message indicating that the error detail was truncated will be included in the file.

Beginning with Tax Year 2016 (PY2017):

- The Error Data File will contain details regarding which business rules were violated.
- The Error Data File will also contain the XPath for each error. The XPath can be used to pinpoint the data element that caused the violation and will be helpful in resolving and correcting errors.
- When same business rule is violated too many times, the entire submission will be rejected and a generic threshold error will be returned in the Error Data File.

New for Tax Year 2017 (PY2018)

- Choice of Receipt ID or UTID to request status -The Receipt ID or the UTID is required for a Transmitter to retrieve the Acknowledgement for the respective transmission.

6.2.1 Error Data File

The sample Error Data File provided above is an example of what the transmitters will receive in the Acknowledgement File when there are errors found in the transmissions. Each field will specify detailed information of the submissions and its errors.

In the example above:

Submission Status Cd specifies the status of one Form 1094 and its Forms 1095

```
<SubmissionLevelStatusCd>Accepted with Errors </SubmissionLevelStatusCd>
```

To understand all the errors regarding Form 1094, follow the *TransmitterErrorDetailGrp* which has

```
<UniqueSubmissionId>1095C-15-00000004|1</UniqueSubmissionId> (ReceiptID | SubmissionID)
```

To understand all the errors regarding Form 1095 for that Form 1094, follow the *TransmitterErrorDetailGrp* which has

```
<UniqueRecordId>1095C-15-00000004|1|1</UniqueRecordId> (ReceiptID | SubmissionID | RecordID )
```

The *TransmitterErrorDetailGrp*, which is a repetitive group, will be present if more than one error is present. The *TransmitterErrorDetailGrp* contains the *ErrorMessageCd*, the *Error MessageText*, and the *XPathContent*. The *XPath* identifies the specific data element and instance in an enumerated group, if applicable, causing the violation.

```

<?xml version="1.0" encoding="UTF-8" standalone="yes"?>
<ns3:FormBCTransmitterSubmissionDtl
  xmlns="urn:us:gov:treasury:irs:ext:aca:air:ty17" xmlns:ns2="urn:us:gov:treasury:irs:common"
  xmlns:ns3="urn:us:gov:treasury:irs:msg:form1094-1095BCTransmittermessage">
  <ACATransmitterSubmissionDetail>
    <TransmitterErrorDetailGrp>
      <SubmissionLevelStatusCd>Accepted with Errors
        </SubmissionLevelStatusCd>
        <UniqueSubmissionId>1095C-15-00000004|1</UniqueSubmissionId>
        </TransmitterErrorDetailGrp>
        <TransmitterErrorDetailGrp>
          <UniqueRecordId>1095C-15-00000004|1|2</UniqueRecordId>
          <ns2:ErrorMessageDetail>
            <ns2:ErrorMessageCd>1095C-041-02</ns2:ErrorMessageCd>
            <ns2:ErrorMessageTxt>If Form 1095C 'BirthDt' in
              'CoveredIndividualGrp' has a value, then it must not occur in the
              future (greater than current processing date)</ns2:ErrorMessageTxt>
            <ns2:XPathContent>/Form109495CTransmittalUpstream/Form1094CUpstreamDetail/Form1095CUpstreamDetail/CoveredInd
              ividualGrp[1]/BirthDt
            </ns2:XPathContent>
          </ns2:ErrorMessageDetail>
        </TransmitterErrorDetailGrp>
        <TransmitterErrorDetailGrp>
          <ns2:ErrorMessageDetail>
            <ns2:ErrorMessageCd>MANIFEST-013</ns2:ErrorMessageCd>
            <ns2:ErrorMessageTxt>The value in Manifest 'TotalPayeeCount' must
              equal the number of 1095s within the submission </ns2:ErrorMessageTxt>
            </ns2:ErrorMessageDetail>
          </TransmitterErrorDetailGrp>
        </TransmitterErrorDetailGrp>
        <UniqueRecordId>1095C-15-00000004|1|1</UniqueRecordId>
        <ns2:ErrorMessageDetail>
          <ns2:ErrorMessageCd>1095C-042-02</ns2:ErrorMessageCd>
          <ns2:ErrorMessageTxt>If Form 1095C 'BirthDt' in
            'CoveredIndividualGrp' has a value, then it must not be earlier
            than Tax Year minus 120 years</ns2:ErrorMessageTxt>
          <ns2:XPathContent>/Form109495CTransmittalUpstream/Form1094CUpstreamDetail/Form1095CUpstreamDetail/CoveredInd
            ividualGrp[1]/BirthDt
          </ns2:XPathContent>
        </ns2:ErrorMessageDetail>
      </TransmitterErrorDetailGrp>
    </ACATransmitterSubmissionDetail>
  </ns3:FormBCTransmitterSubmissionDtl>

```

Figure 6-1: Sample of an Error Data File

```

<?xml version="1.0" encoding="UTF-8" standalone="yes"?>
<ns3:FormBCTransmitterSubmissionDtl
  xmlns="urn:us:gov:treasury:irs:ext:aca:air:7.0" xmlns:ns2="urn:us:gov:treasury:irs:common"
  xmlns:ns3="urn:us:gov:treasury:irs:msg:form1094-1095Bctransmittermessage">
  <ACATransmitterSubmissionDetail>
    <TransmitterErrorDetailGrp>
      <UniqueRecordId>1095B-16-00002116|1|1</UniqueRecordId>
      <ns2:ErrorMessageDetail>
        <ns2:ErrorMessageCd>1095B-055-01</ns2:ErrorMessageCd>
        <ns2:ErrorMessageTxt>Form 1095B 'CoveredIndividualName' and 'SSN'
          within 'CoveredIndividualGrp' must match the IRS database
        </ns2:ErrorMessageTxt>
        <ns2:XpathContent>/Form109495BTransmittalUpstream/Form10948UpstreamDetail/Form1095BUpstreamDetail/CoveredIndividualGrp[1]/SSN
        </ns2:XpathContent>
      </ns2:ErrorMessageDetail>
    </TransmitterErrorDetailGrp>
    <TransmitterErrorDetailGrp>
      <UniqueRecordId>1095B-16-00002116|1|2</UniqueRecordId>
      <ns2:ErrorMessageDetail>
        <ns2:ErrorMessageCd>1095B-052-01</ns2:ErrorMessageCd>
        <ns2:ErrorMessageTxt>Form 1095B 'BusinessName' and 'EIN' within
          'IssuerInfoGrp' must match the IRS database</ns2:ErrorMessageTxt>
        <ns2:XpathContent>/Form109495BTransmittalUpstream/Form10948UpstreamDetail/Form1095BUpstreamDetail/IssuerInfoGrp/EIN
        </ns2:XpathContent>
      </ns2:ErrorMessageDetail>
    </TransmitterErrorDetailGrp>
    <TransmitterErrorDetailGrp>
      <UniqueRecordId>1095B-16-00002116|1|2</UniqueRecordId>
      <ns2:ErrorMessageDetail>
        <ns2:ErrorMessageCd>1095B-055-01</ns2:ErrorMessageCd>
        <ns2:ErrorMessageTxt>Form 1095B 'CoveredIndividualName' and 'SSN'
          within 'CoveredIndividualGrp' must match the IRS database
        </ns2:ErrorMessageTxt>
        <ns2:XpathContent>/Form109495BTransmittalUpstream/Form10948UpstreamDetail/Form1095BUpstreamDetail/CoveredIndividualGrp[1]/SSN
        </ns2:XpathContent>
      </ns2:ErrorMessageDetail>
    </TransmitterErrorDetailGrp>
  </ACATransmitterSubmissionDetail>
</ns3:FormBCTransmitterSubmissionDtl>

```

Figure 6-2: Sample of an Error Data File with TIN Validation (500)

6.2.2 Retrieving Acknowledgements via the UI Channel

The Transmitter will log in to the appropriate UI Channel link (AATS or Production) available on the [Affordable Care Act Information Returns \(AIR\) Program](#) page on IRS.gov to submit a request to retrieve the processing status and error detail of their transmission, which is known as the Acknowledgement. In order to retrieve the Acknowledgement, the Transmitter must select the option to retrieve Acknowledgement and provide their Transmitter Control Code (TCC) and the Receipt ID or the UTID from the transmission for which they are requesting the processing status. Once the required information is interactively entered, the user submits the request.

Note: When retrieving acknowledgements via the UI Channel, no XML files are required to be uploaded.

IRS retrieves the transmission status and provides the capability to view the error detail, if processing errors were identified as part of the synchronous session. From the UI Channel, the Error Data File may also be downloaded by the Transmitter for detailed analysis of the corrections required.

For details on how to construct and receive status and acknowledgements, see Publication 5258, *AIR Submission Composition and Reference Guide*, on the [Affordable Care Act Information Returns \(AIR\) Program](#) page.

6.2.3 Retrieving Acknowledgements via the A2A Channel

The Transmitter will be required to include their digital certificate and a digitally signed hash of the message in the WS-Security Header of the SOAP Message and invoke the appropriate URL for the Web Service endpoint that exposes the IRS-ACAackngService service within the ACAGetTransmitterBulkRequestStatus.wsdl. The Receipt ID or the UTID is required for a Transmitter to retrieve the Acknowledgement for the respective transmission. Required information pertaining to the Transmitter and the transmission are included as part of the SOAP message (in the SOAP Header) that is transmitted to IRS in a SOAP Request message.

IRS validates the SOAP message and performs security scanning and XML Schema validation on the inbound transmission. If threats are detected or XML Schema validation fails, IRS will reject the transmission and inform the Transmitter of the rejection. If no security threats are detected, IRS retrieves the acknowledgement including the status and the Error Data File (if processing errors were identified by IRS), and returns them in the SOAP Response message as part of the synchronous session. The Error Data File (if included) is an uncompressed native XML formatted file that will not exceed 200 MB attached to the message as an MTOM encoded attachment.

7 Corrections and Replacements

7.1 Corrections Process

Corrections can only be made to previous transmissions that have been Accepted, Accepted with Errors or Partially Accepted. Transmitters should file corrections with IRS as soon as possible and furnish a copy of the corrected return to the Recipient. Transmissions containing correction records must only contain corrections and should not include any “Originals”. Corrections may be filed for the following form types:

- Form 1095-B
- Form 1094-C, Authoritative Transmittals only
- Form 1095-C

Note: Although both the Form 1094-B and Form 1094-C are transmittal forms, the Form 1094-B is purely a transmittal document and, therefore, does not require corrections. The Form 1094-C Authoritative Transmittal contains additional information that may need correction. The Form 1094-C must be submitted alone when a correction is required to the Form 1094-C, Authoritative Transmittal itself. Otherwise, the Form 1094-C must be submitted with one or more “corrected” Forms 1095-C.

The correction process can be utilized when:

- IRS notifies the Transmitter or Issuer of one or more errors on the transmittal (Form 1094-C Authoritative Transmittal) or information returns (Forms 1095-B or Forms 1095-C) filed.
- The Transmitter or Issuer identifies one or more errors on the transmittal (Form 1094-C Authoritative Transmittal) or information returns (Forms 1095-B or Forms 1095-C) filed.
- The Employee or Covered Individual reports an error

The unique identifiers assigned by AIR allow corrections to the specific record(s), both transmittal records (Forms 1094) and information return records (Forms 1095) defined above in Section 3.

See the example and figure below illustrating multiple corrections to a single record.

For example, the Form 1094 data located in submission 10 of a transmission would have a USID as follows:

USID= 1094B-18-00700283|10

The Form 1095 data located in record 2 of submission 10 of a transmission would have a URID as follows:

URID= 1094B-18-00700283|10|2

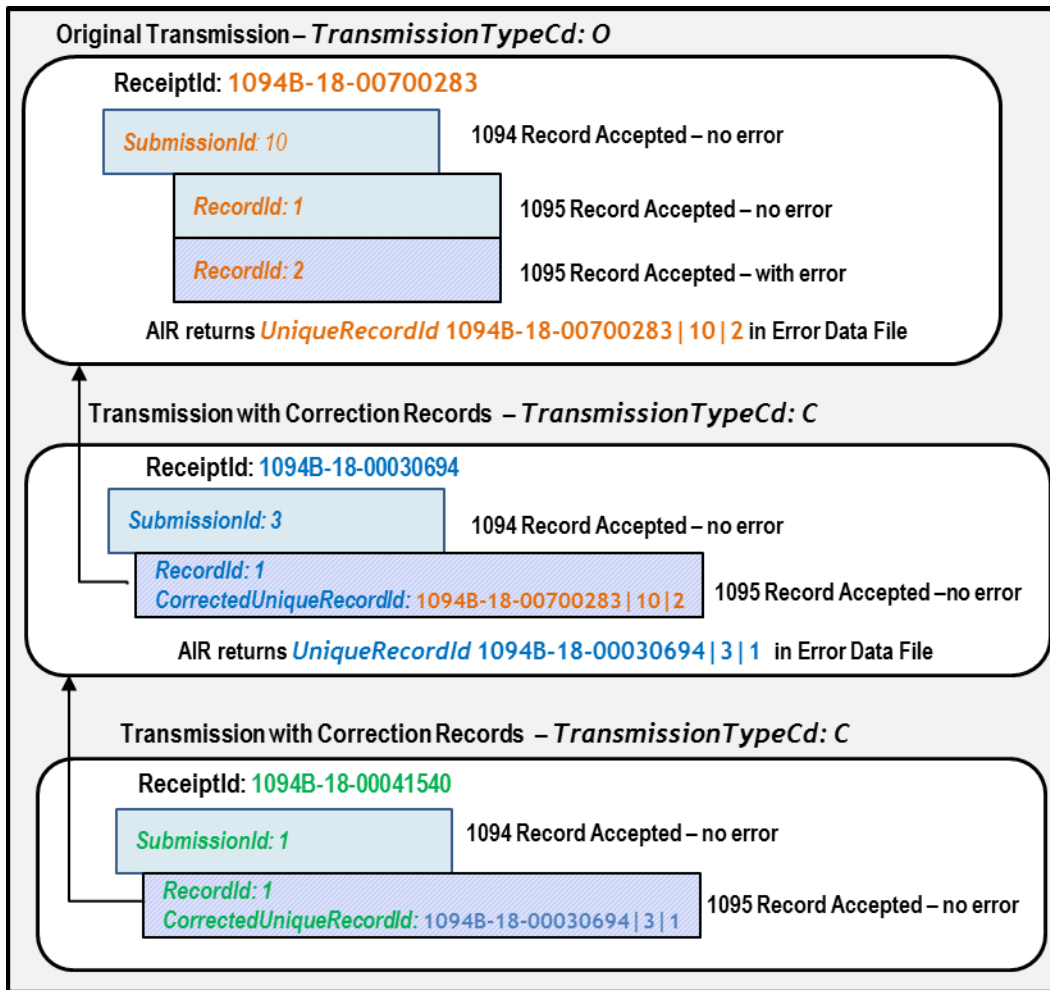

Figure 7-1: Reference Records to be Corrected

Guidelines for transmitting corrections:

- Do not submit original and corrected documents in the same file.
- If the transmission is identified as containing corrections in the Manifest (*TransmissionTypeCd* is ‘C’), then the “*CorrectedInd*” in the Form Data File has to be set to “1” and must include either the “*CorrectedUniqueSubmissionId*” (if the correction is for Form 1094-C) or the “*CorrectedUniqueRecordId*” (if the correction is for Form 1095) which references the record that is being corrected.

- If a Correction is found to be in error and needs to be corrected, submit a Correction to the most recently accepted Correction – **File only one Correction per Unique Submission ID when correcting a Form 1094-C Authoritative Transmittal or Unique Record ID when correcting a Form 1095.**
- Correction records will carry both a “Record ID” to uniquely identify the correcting record, as well as the Unique ID of the 1094-C or 1095 Record to be corrected
 - For Form 1094-Cs use “*SubmissionId*” and “*CorrectedUniqueSubmissionId*”
 - For Form 1095-Bs and Cs use “*RecordId*” and “*CorrectedUniqueRecordId*”
- Always include the complete record for Correction; do not supply only the Corrected data elements within the correcting record.
- When the transmission is Accepted with Errors and the only errors identified are Manifest errors with a severity of “Report Error”, these errors cannot be corrected and the messages are for informational purposes only.

7.1.1 Transmitting Corrections

Form 1094-C Correction Process (Authoritative Transmittals Only)

If an original transmission requires corrections to the Form 1094-C Authoritative Transmittal, include the following (see schema and business rules):

- Populate the Form 1094-C “*CorrectedInd*” with “1”
- A “*UniqueTransmissionId*” for the transmission
- A “*TransmissionTypeCd*” in the Manifest should be “C” for corrections
- A “*SubmissionId*” (SID) for the correction Transmittal record
- The “*CorrectedUniqueSubmissionId*” (CUSID) identifying the record that is being corrected

Examples of key data fields from the original record to be corrected are the Name of ALE Member (Employer) and the Employer Identification Number (EIN). **Note:** These fields are necessary to allow IRS to associate the correction record to the original record even when the Unique ID’s don’t match. Do *not* attach any Forms 1095-C.

When correcting Form 1094-C Authoritative Transmittal entity data that also appears on associated Forms 1095-C (Name and EIN), it is not necessary to submit changes to every associated Form 1095-C in order to correct that information on the Forms 1095-C. IRS internal systems will associate appropriate entity information to existing Form 1095-C records.

Forms 1095-B or 1095-C Correction Process

If an original transmission requires corrections to the Forms 1095-B and 1095-C, include the following (see schema and business rules):

- Populate the Form 1095-B or 1095-C “*CorrectedInd*” with “1”. **Note: The “*CorrectedInd*” in the Form 1094-C should be “0”. The Form 1094-B is purely a transmittal document and, therefore, does not have a “*CorrectedInd*”.**
- A “*UniqueTransmissionId*” for the transmission
- “*TransmissionTypeCd*” in the Manifest should be “C” for corrections
- A “*SubmissionId*” for the Transmittal (Form 1094) record
- A “*RecordId*” of the correction record

- The “*CorrectedUniqueRecordId*” (*CURID*) identifying the record that is being corrected
Key data fields from the original record to be corrected, e.g., Recipient Name and TIN. Note: these fields are necessary to allow IRS to associate the correction record to the original record even when the Unique ID’s don’t match.

Form 1094-C and Form 1095-C Correction Process

If an original transmission requires corrections to **both** the Forms 1094-C Authoritative Transmittal and 1095-C, please file two separate transmissions.

- The **first** transmission will be to correct the Form 1094-C Authoritative Transmittal only, by following the Form 1094-C Authoritative Transmittal Correction Process outlined above.
- The **second** transmission will be to correct the Form 1095-C by following the Form 1095-C Correction Process outlined above. Only complete the accompanying Form 1094-C through the element “*Form1095CAAttachedCnt*” (Line 18). Please note: The element “*AuthoritativeTransmittalInd*” (Line 19 and Parts II, III and IV of the Form 1094 C, should **not** be completed.

If, after submitting a correction, IRS identifies a subsequent error, or if the Transmitter identifies a subsequent error, **you must utilize the Unique IDs associated with the correction.** See Figure 7-1.

Note: The original record may only be corrected once.

7.2 Replacement Process

Replacements are filed when the transmissions or submissions are ‘**Rejected**’ by IRS. A replacement transmission must contain all of the records submitted to IRS for processing in the rejected Transmission that is being replaced. **Transmitters should submit an acceptable replacement transmission no later than 60 days after the original transmission date, if the original transmission date is on or before the ACA Information Returns due date.** When an acceptable replacement file is submitted within 60 days from the original transmission date, the file will be treated as filed on the original transmission date. If an acceptable replacement file is submitted after the 60 day period, the file will be treated as filed on the date the replacement file is submitted and the payer could be subject to late filing penalties.

Note: Transmitters should wait until a transmission is successfully processed by IRS before submitting a replacement. Transmitters cannot submit replacement transmissions/submissions until the previous transmissions are rejected and not replaced.

7.2.1 Transmissions Rejected by IRS Portal

When a transmission is rejected by IRS Portal, the Transmitter will receive a fault (error) code that is prefixed with ‘TPE’. The corresponding error description message will contain information about the errors that was detected. The table of fault codes produced by IRS Portal is included in Section 4.4 of this document.

When a transmission is rejected by IRS Portal, the Transmitter must fix the problem that caused the rejection and should resend the same transmission with no other changes. The only exception is if the transmission is rejected because the message size is too large (the Form Data File exceeds the 100 MB size limitation). In the case where the message size is too large, the Transmitter must reduce the number of records in the Form Data File before resending the transmission.

7.2.2 Transmissions Rejected by AIR

Replacement transmissions must be filed when a transmission is rejected by AIR. When AIR rejects the transmission, the Error Code returned to the Transmitter will be prefixed with 'AIR'. The AIR System now provides Submission level rejections, along with Transmission level rejections. None of the records included in a transmission/submission that are rejected are maintained in IRS data stores. Thus, when a transmission or submission is rejected by AIR, a replacement transmission or submission must be submitted.

In addition, the Manifest XML Schema includes the element "*OriginalReceiptId*" which includes the Receipt Id of the transmission being replaced. This element is used when submitting a Transmission Replacement. The Transmitter receives a Receipt ID when they submit a transmission containing ACA Information Returns to IRS.

The Form Data File contains the data element "*OriginalUniqueSubmissionId*" which allows a submission to be replaced. When submissions are replaced, the Manifest Data element "*OriginalReceiptId*" is not used.

These identifiers allow for referencing a transmission or submission that was rejected and must be replaced.

Only transmissions that contained original records (*TransmissionTypeCd* is 'O') that were rejected require a replacement transmission. When a transmission, containing original records, is rejected (*TransmissionTypeCd* is 'O'), the Transmitter must fix the problem that caused the rejection and resend the same transmission as a replacement (*TransmissionTypeCd* is 'R'). However, if a transmission or submission containing correction records is rejected (*TransmissionTypeCd* is 'C'), the Transmitter must fix the problem that caused the rejection and resubmit that transmission or submission within a transmission that uses '*TransmissionTypeCd* 'C'.

An individual Original Submission within a 'Partially-Accepted' Transmission can be rejected by IRS and replaced by the Transmitter.

The following are reasons for a rejection at the Transmission level or Submission level (Forms 1094/1095-B and 1094/1095-C);

- a) A complete Transmission can be rejected due to:
 - A fatal error identified while processing the transmission metadata
 - Schema validation failed on the Form Data XML File
 - All submissions within the transmission are rejected

Note - The above situation requires the Transmitters to replace the entire Transmission.

- a) Submission level rejections can occur due to Business Rules Failures (ex: Form 1094 Incorrect or Missing Tax Year), which will lead to a particular Submission rejection (Form 1094 and its corresponding 1095 Forms).

Note: The above situation requires the Transmitters to replace only that rejected Submission, EXCEPT when all Submissions within a Transmission are rejected. If all Submissions are rejected within a Transmission, the entire transmission must be replaced.

7.2.3 Transmitting Replacements

Transmitters are able to file certain Replacement Transmissions, as well as Replacement Submissions.

- Replace a Transmission when the original Transmission Status was "Rejected"

- Replace a Submission when the original Transmission Status was "Partially Accepted" and the Submission status was "Rejected"

The forms contained within the Replacement Transmissions or Submissions must be the same as their corresponding rejected original Transmissions/Submissions that are being replaced.

7.2.3.1 Replacing an Original Transmission that Rejected

If the original Transmission was “Rejected”, then replace the entire Transmission by using the Receipt ID from the Rejected Transmission to populate the Manifest Data element ‘*OriginalReceiptId*’ of the Replacement Transmission.

Replacement transmissions must include the following requirements (see schema and business rules for additional details):

- A “*UniqueTransmissionId*” for the replacement transmission (ACA Business Correlation ID (*UniqueTransmissionId*) in the Manifest should be unique for each transmission (UUID which is part of UTID will be checked for uniqueness against that TCC)
- “*TransmissionTypeCd*” in the Manifest should be “R” for replacements
- Include the “*OriginalReceiptId*” data element identifying the original transmission that is being replaced
- *DocumentSystemFileNm* in the Manifest should match the name of the Form Data File
- *ChecksumAugmentationNum* in the Manifest should be unique for each transmission

Do not:

- Include any additional or new submissions
- Include the “*OriginalUniqueSubmissionId*” in the Form Data File
- **Try to replace individual submissions within a rejected transmission**
- Try to replace a transmission that was not rejected
- Try to replace a transmission that has been successfully replaced

7.2.3.2 Replacing a ‘Replacement’ Transmission that Rejected

If an original Transmission is rejected and the Replacement Transmission is also rejected, then replace the first (Earliest) rejected Transmission in the chain by populating the Manifest Data element ‘*OriginalReceiptId*’ with the Receipt Id that references the EARLIEST rejected Transmission in the chain. Replacement Transmissions must include the following requirements (see schema and business rules for additional details):

- A “*UniqueTransmissionId*” for the replacement transmission (ACA Business Correlation ID (*UniqueTransmissionId*) in the Manifest should be unique for each transmission (UUID which is part of UTID will be checked for uniqueness against that TCC)
- “*TransmissionTypeCd*” in the Manifest should be “R” for replacements
- Include the “*OriginalReceiptId*” data element identifying the Receipt Id that references the first rejected transmission, which contained a *TransmissionTypeCd* of "O", in the chain
- *DocumentSystemFileNm* in the Manifest should match the name of the Form Data File
- *ChecksumAugmentationNum* in the Manifest should be unique for each transmission
- Replacement transmission should not include any additional or new submissions

Do not:

- Include the “*OriginalUniqueSubmissionId*” in the Form Data File
- Try to replace a rejected replacement transmission

- Try to replace individual submissions within a rejected transmission
- Try to replace a transmission that was not rejected
- Try to replace a transmission that has been successfully replaced

Figure 7-2 depicts the replacement process where both the initial transmission and the first replacement attempt were rejected by AIR.

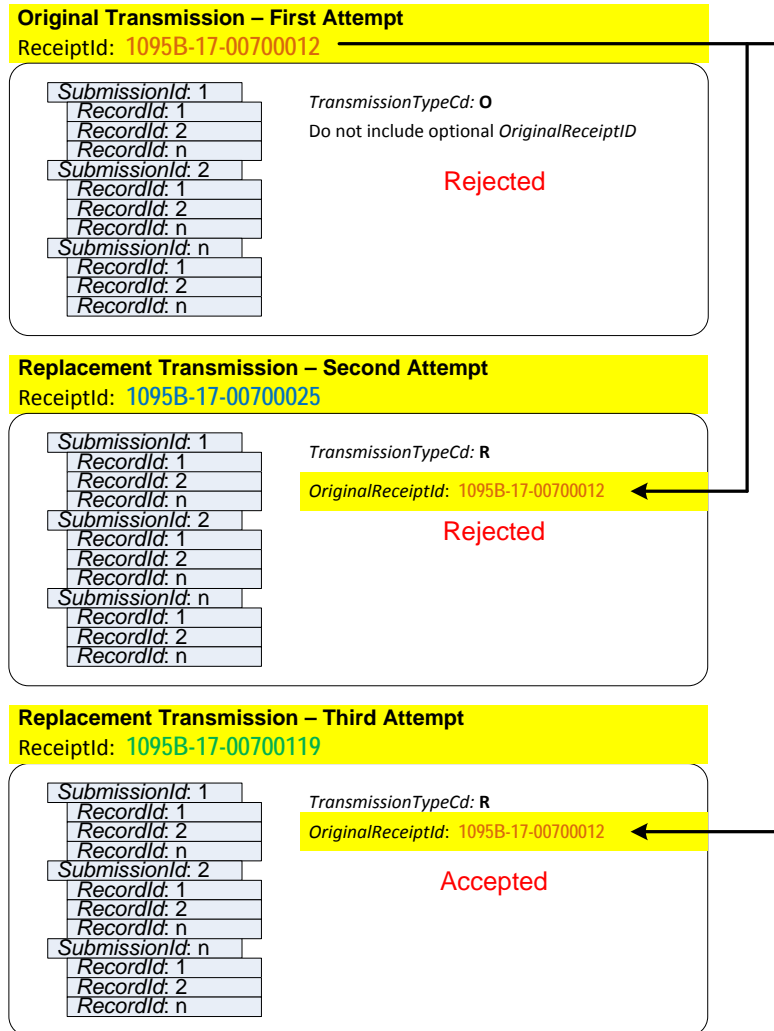

Figure 7-2: Replacing a Rejected Transmission

7.2.3.2.1 Replacing Submissions within a Partially Accepted Transmission

If the original Transmission is Partially-Accepted, then replace the individual Submission(s) that were rejected by populating the data element “OriginalUniqueSubmissionId” in each replacement Submission Header (Form 1094) with the “UniqueSubmissionId” from the Submission Header of the rejected Submission(s). When filing replacement Submission(s) for submissions that were rejected within a Partially Accepted Transmission, adhere to the following requirements (see schema and business rules for additional details):

- “TransmissionTypeCd” in the Manifest should be “R” for replacement

- Include the “*OriginalUniqueSubmissionId*” in the Form Data File identifying the submission that is being replaced
- **Duplicate replacement Submission ID(s) included within the same transmission will be rejected.**
- **Replacement transmission should not include any new submissions**
- **Do not:**
 - Include the “*OriginalReceiptId*” data element
 - Try to replace a Partially Accepted Transmission by replacing the entire original Transmission.

7.2.3.2.2 Replacing Submissions within a Partially Accepted ‘Replacement’ Transmission

If the Original Transmission was Rejected and the ‘Replacement’ Transmission is Partially Accepted (one or more of the replacement submissions are rejected), then replace the first rejected *Submission(s)* in the chain where the Transmission was Partially Accepted.

- “*TransmissionTypeCd*” in the Manifest should be “R” for replacement
- Include the “*OriginalUniqueSubmissionId*” in each *replacement* submission header (Form 1094) with the Unique Submission ID from the header within the earliest Partially Accepted Transmission that is being replaced
- **Duplicate replacement Submission ID(s) included within the same transmission will be rejected.**
- **Replacement transmission should not include any new submissions**
- **Do not:**
 - Include the “*OriginalReceiptId*” data element.
 - Submit a submission-level replacement for a transmission that was rejected

7.2.3.2.3 Replacing Submissions from an Original Transmission that was Partially Accepted when the Replacement Submission(s) Transmission was Rejected

If the original Transmission is Partially-Accepted, and the replacing Transmission with the replacement submissions is Rejected, then transmit another transmission with replacement submissions by populating the data element ‘*OriginalUniqueSubmissionId*’ with the *UniqueSubmissionId* from the submission header of the “*Originally*” rejected Submission(s) within the Partially-Accepted Transmission. When filing a replacement Submission within a Partially Accepted Transmission, adhere to the following requirements (see schema and business rules for additional details):

- “*TransmissionTypeCd*” in the Manifest should be “R” for replacement
- Include the “*OriginalUniqueSubmissionId*” in the Form Data File identifying the submission that is being replaced from the original Partially Accepted transmission
- **Duplicate replacement Submission ID(s) included within the same transmission will be rejected.**
- **Replacement transmission should not include any new submissions**
- **Do not:**
 - Include the “*OriginalReceiptId*” data element.
 - Replace a submission within a Submission Replacement Transmission that was rejected

8 Extension of Time to File

A request for an automatic 30-day extension of time to file AIR Forms 1095-B and 1094/1095-C will be available in January 2018. The Form 8809, *Application for Extension of Time to File Information Returns*, cannot be filed through the AIR System. The 30-day extension request can be submitted by three different methods:

- A paper submission of Form 8809
- An Electronic File Transmission through the FIRE Production System (FIRE TCC needed)
- An online Fill-in Form 8809 may be completed via the FIRE Production System

For more information on extensions for Information Returns see instructions for Form 8809 and Publication 1220.

Request for an Additional Extension of Time

Under certain hardship conditions you may apply for an additional 30-day extension if the initial extension of time to file is granted and the additional extension is filed before the expiration of the automatic 30 day extension. The *additional 30-day extension* request can only be submitted by filing a paper Form 8809.

Extension of Time to Provide the Recipient Copy

The due date for furnishing the Form 1095-B and 1095-C to the Recipients (employee/or covered individual) is January 31st. The request for an extension of time to provide the Recipient copy must be postmarked by the date on which the statements are due to the Recipients (January 31). The letter must contain the following; Issuer, Name, TIN, Address, Type of Return, Reason for Delay, statement saying the request is for Recipient copies, and signature of the Issuer or Authorized Agent. The request should be mailed to:

Internal Revenue Service
Attn: Extension of Time Coordinator
240 Murall Drive, Mail Stop 4360
Kearneysville, WV 25430

If the extension is granted, it will allow a maximum of 30 additional days to furnish copies to the Recipients. No additional extensions are allowed.

9 Waiver from Filing Electronically

ACA Information Returns Forms 1094/1095-B and 1094/1095-C are covered under Internal Revenue Code (IRC) section 6011(e). IRC 6011(e) requires filers of 250 or more information returns to file electronically. The electronic filing requirement does not apply if you apply for and receive a hardship waiver. If the filer is required to submit information returns electronically and fails to do so, and there is not an approved waiver on record, the filer may be subject to a penalty for failure-to-file electronically.

Form 8508, *Request for Waiver from Filing Information Returns Electronically*, is used to request a waiver from filing AIR Forms 1094/1095-B and 1094/1095-C) for Tax Year 2017. A separate Form 8508 must be submitted for each employer or insurance issuer/carrier.

Form 8508 may be filed beginning in January 2018 and should be submitted at least 45 days before the due date of the information return. The form cannot be filed electronically and must be submitted to the address shown in the instructions for Form 8508.

Refer to Form 8508 for detailed instructions on completing the form and Publication 1220 for more information.

10 Appendix Additional Resources

- [Standard Postal Service State Abbreviations and ZIP Codes](#)
- [Foreign Country Codes](#)
- For details on Name Control for Businesses, see Section 3.11 in [Publication 4163](#)
- For details on Name Control for Individuals, see Exhibit 5 in [Publication 4164](#)
- For details on Social Security and Taxpayer Identification Numbers, see Exhibit 6 in [Publication 4164](#)